

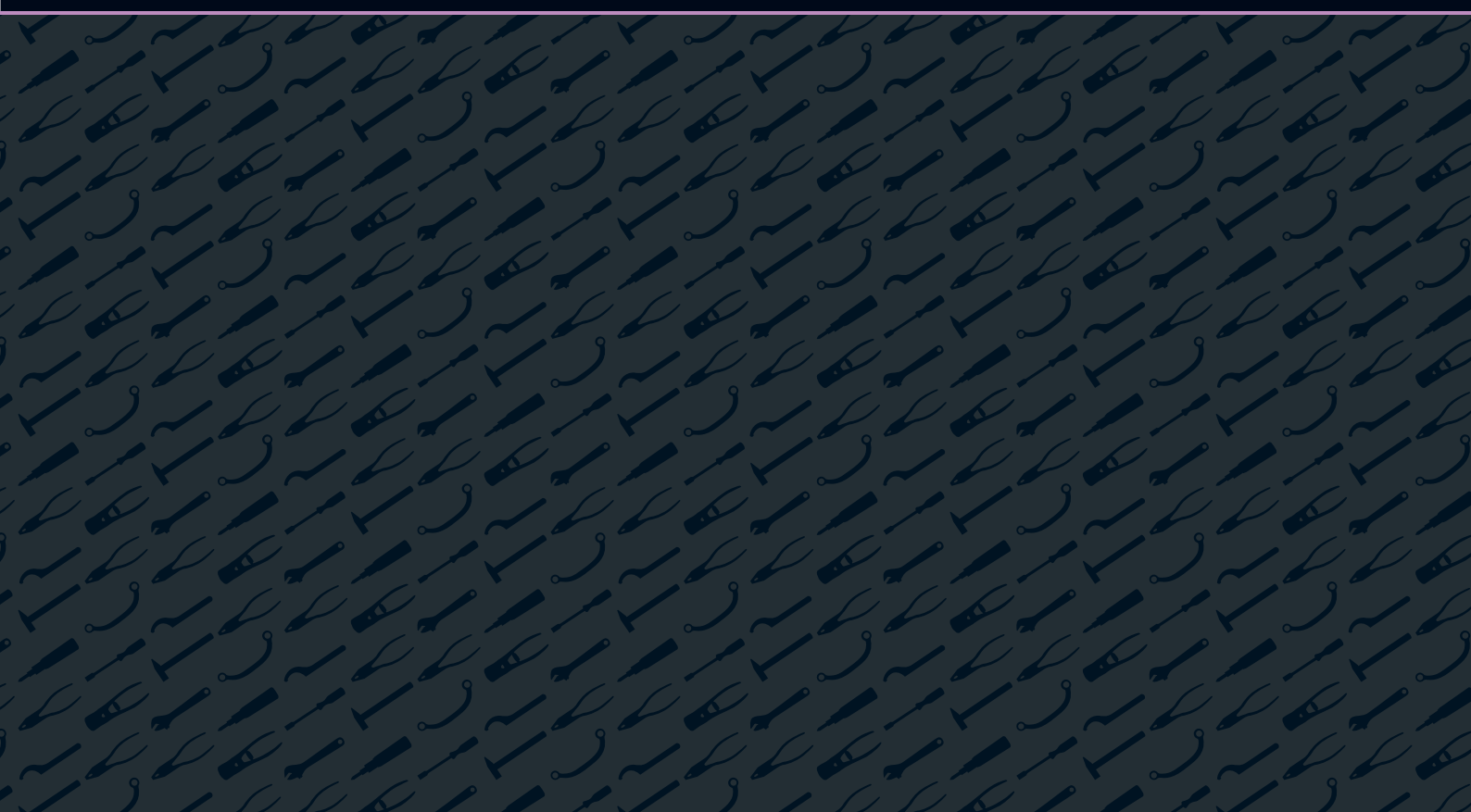

Schraubenschlüssel

Spanners & wrenches



Schraubenschlüssel Spanners & wrenches

Vom Elektrikerschlüssel Nr. 160 - 3,2 mm bis zum Schlag-schlüssel Nr. 580 - 230 mm stellen die Schraubenschlüssel die Basis des Carl Walter Programms dar. Aus gutem Grund vertrauen Ingenieure und Mechaniker seit mehr als 80 Jahren auf die bewährte Qualität von Walter Schlüsseln:

- Walter Schlüsseln übertreffen die Anforderungen von nationalen und internationalen Normen.
- Aufgrund sorgfältiger Konstruktion und Berechnung werden hohe Drehmomente bei geringen Abmessungen erreicht.
- Walter ENERGY Profil als Standard. Dieses Profil verlagert beim Schrauben den Belastungspunkt von der Ecke zur Flanke des Schraubenkopfes. Dadurch wird der Schraubenkopf geschont und die Drehmomente können noch weiter erhöht werden.
- Walter Schlüsseln werden aus hochwertigem Vergütungsstahl (31CrV3 / 51CrV4, etc.) im Gesenk geschmiedet.
- Die Schlüsselweiten werden durch spanende Bearbeitung kalibriert.
- Um einer Randentkohlung (Weichhaut) bei der Wärmebehandlung entgegenzuwirken, erfolgt die Vergütung der Walter Schlüsseln unter Ausschluss von Sauerstoff.
- Bei Walter Schlüsseln können Sie zwischen zwei verschiedenen Oberflächen-Ausführungen wählen:
 - einer hochwertigen, dauerhaften Matt-Verchromung
 - einer schlagbeständigen Phosphatierung, die einen dauerhaften Korrosionsschutz bietet.
- Zur Sicherung des hohen Qualitätsniveaus unterliegen die Schraubenschlüssel wie alle Produkte des Hauses Carl Walter ständigen Qualitätskontrollen.

From electrician spanner Nr. 160 size 3,2 mm up to a slugging wrench Nr. 580 size 230 mm the production of spanners and wrenches is the basis of the CARL WALTER range. There are good reasons why engineers and mechanics rely on Walter spanners for more than 80 years:

- Walter spanners comply with or exceed the requirements of the relevant national and international standards.
- Due to our know-how in spanner production Walter spanners and wrenches designed to offer highest loadability at smallest possible dimensions.
- All popular metric ring spanners with the Walter Energy-profile as standard. This transfers the loading point from the corner of the bolt to the flanks which protects the bolt from any damage and allows to even further increase applicable loads.
- Walter spanners are drop forged from high quality alloyed steels (31CrV3 / 51CrV4, etc.).
- Walter spanners are calibrated by cutting processes.
- To prevent from a decarbonization of surface, all Walter spanners are heat treated under exclusion of oxygen.
- On Walter spanners you can select out of two different finishes:
 - a high quality, durable chrome plating in matt finish
 - an impact-resistant phosphating for a permanent protection against corrosion.
- To guarantee the high quality level the Walter spanners as well as all other products of our company are constantly surveyed by our quality control department.

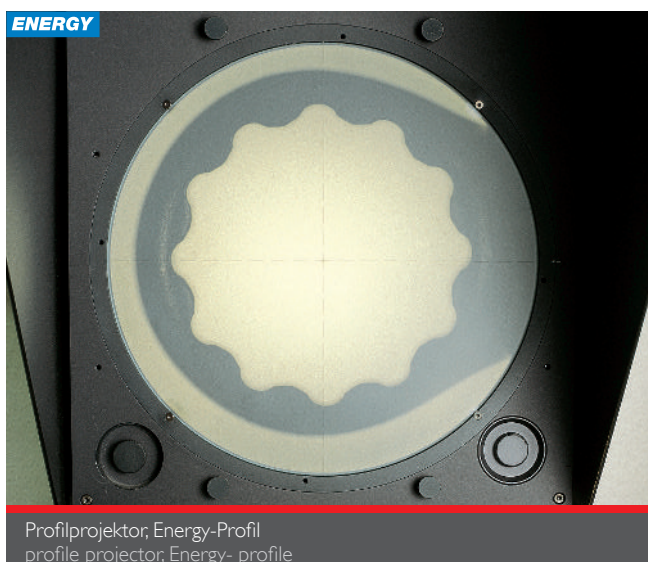

Profilprojektor, Energy-Profil
profile projector, Energy-profile

Doppelmaulschlüssel
 DIN 3110 – ISO 3318 / ISO 1085
 Chrom-Vanadium-Stahl, verchromt, Köpfe geschliffen,
 Maulstellung: 15°

Double open ended spanner
 DIN 3110 – ISO 3318 / ISO 1085
 chrome vanadium steel, chrome plated,
 heads smoothly grinded, position of open ends: 15°

100 C



Artikel-Nr. Order-No.	Ident-Nr. Ident-No.	mm	€	L		
100 C	00052	4 x 5	6,30	110	16	10
100 C	00092	6 x 7	3,75	123	22	10
100 C	00102	7 x 8	4,30	132	30	10
100 C	00122	8 x 9	3,90	143	30	10
100 C	00132	8 x 10	4,20	143	30	10
100 C	00152	9 x 11	4,90	157	46	10
100 C	00162	10 x 11	4,65	157	48	10
100 C	00172	10 x 12	4,90	157	45	10
100 C	00182	10 x 13	5,75	171	64	10
100 C	00192	11 x 13	5,75	171	69	10
100 C	00202	12 x 13	5,40	172	64	10
100 C	00222	12 x 14	5,75	180	69	10
100 C	00232	13 x 14	5,85	180	81	10
100 C	00242	13 x 15	6,30	190	88	10
100 C	00252	14 x 15	6,05	190	88	10
100 C	00032	13 x 16	7,80	190	100	10
100 C	00262	13 x 17	6,50	190	96	10
100 C	00272	14 x 17	6,50	190	97	10
100 C	00282	16 x 17	6,50	205	124	10
100 C	00532	16 x 18	7,60	220	110	10
100 C	00292	17 x 19	7,60	220	156	10
100 C	00302	18 x 19	7,60	220	156	10
100 C	00072	18 x 21	11,45	235	214	10
100 C	00322	19 x 22	8,75	235	209	10
100 C	00332	20 x 22	8,70	237	200	10
100 C	00342	21 x 23	9,10	250	235	5
100 C	00352	19 x 24	9,50	245	240	5
100 C	00512	21 x 24	12,40	250	230	5
100 C	00362	22 x 24	9,65	250	244	5
100 C	00382	24 x 26	10,80	270	320	5
100 C	00392	24 x 27	10,80	270	295	5
100 C	00402	24 x 30	12,95	285	360	5
100 C	00412	25 x 28	12,70	280	370	5
100 C	00432	27 x 30	15,65	295	466	5
100 C	00442	27 x 32	15,50	302	468	5
100 C	00452	30 x 32	15,50	295	492	5
100 C	00612	30 x 34	26,80	320	477	3
100 C	00462	30 x 36	24,65	320	526	3
100 C	00642	32 x 34	31,45	323	600	3
100 C	00472	32 x 36	24,65	323	600	3
100 C	00622	34 x 36	31,45	323	586	3
100 C	00482	36 x 41	32,55	350	723	3
100 C	00492	41 x 46	48,30	425	1295	1
100 C	00502	46 x 50	64,10	475	1665	1
100 C	00632	55 x 60	168,50	627	3135	1

Amerikanische Zollmaße AF"

AF"

Artikel-Nr. Order-No.	Ident-Nr. Ident-No.	AF"	€	L		
100 C	00652	1/4 x 5/16	4,35	123	20	10
100 C	00662	5/16 x 3/8	4,35	143	34	10
100 C	00672	3/8 x 7/16	5,00	157	46	10
100 C	00682	7/16 x 1/2	5,75	171	74	10
100 C	00692	1/2 x 9/16	5,95	180	83	10
100 C	00702	9/16 x 5/8	6,40	190	89	10
100 C	00712	5/8 x 11/16	8,30	205	135	10
100 C	00722	5/8 x 3/4	8,65	220	165	10
100 C	00732	11/16 x 3/4	8,75	220	169	10
100 C	00742	3/4 x 7/8	11,45	235	230	10
100 C	00752	13/16 x 7/8	9,75	236	207	10
100 C	00772	15/16 x 1	11,90	270	308	5
100 C	00792	1 x 1 1/8	15,45	280	356	5
100 C	00802	1 1/16 x 1 1/4	16,75	302	430	5
100 C	00822	1 7/16 x 1 5/8	40,20	355	736	1

Schraubenschlüssel Spanners & wrenches

100 C



Satz in Karton

Set in carton

Artikel-Nr. Order-No.	Ident-Nr. Ident-No.	€	Inhalt Content	mm		
100/6 C	00542	32,50	6x7, 8x9, 10x11, 12x13, 14x15, 16x17		380	I
100/7 C	00552	57,50	6x7, 8x9, 10x11, 12x13, 14x15, 16x17, 18x19		660	I
100/8 C	00572	49,50	6x7, 8x9, 10x11, 12x13, 14x15, 16x17, 18x19, 20x22		860	I
100/10 C	00582	68,00	6x7, 8x9, 10x11, 12x13, 14x15, 16x17, 18x19, 20x22, 21x23, 24x27		1390	I
100/12 C	00592	96,00	6x7, 8x9, 10x11, 12x13, 14x15, 16x17, 18x19, 20x22, 21x23, 24x27, 25x28, 0x32		2250	I

Amerikanische Zollmaße AF"

AF"

Artikel-Nr. Order-No.	Ident-Nr. Ident-No.	€	Inhalt Content	AF"		
100/6 C	00892	46,00	1/4 x 5/16, 3/8 x 7/16, 1/2 x 9/16, 5/8 x 3/4, 13/16 x 7/8, 15/16 x 1		830	I
100/8 C	00902	68,00	1/4 x 5/16, 5/16 x 3/8, 7/16 x 1/2, 9/16 x 5/8, 11/16 x 3/4, 13/16 x 7/8, 15/16 x 1, 1 1/16 x 1 1/4		1340	I
100/12 C	01042	153,00	1/4 x 5/16, 5/16 x 3/8, 3/8 x 7/16, 7/16 x 1/2, 1/2 x 9/16, 9/16 x 5/8, 11/16 x 3/4, 13/16 x 7/8, 15/16 x 1, 1 x 1 1/8, 1 1/16 x 1 1/4, 1 7/16 x 1 5/8		2560	I

100 C



Satz in Sichtkarton

Set in display carton

Artikel-Nr. Order-No.	Ident-Nr. Ident-No.	€	Inhalt Content	mm		
100/8 C	100 0083 020	46,00	6x7, 8x9, 10x11, 12x13, 14x15, 16x17, 18x19, 20x22		650	I



Härten
härten

Elektronik-Doppelmaulschlüssel
 beide Seiten gleiche Schlüsselweite,
 15° und 75° abgewinkelt, extra dünne Mäuler,
 Spezial-Werkzeugstahl, verchromt

Electronic* double open ended spanner
 same size at both ends,
 jaws angled 15° and 75°, extra thin jaws,
 special tool steel, chrome plated

160



Artikel-Nr. Order-No.	Ident-Nr. Ident-No.	mm	€	L		
160	160 0032 010	3,2	7,60	65	5	10
160	160 0035 010	3,5	7,60	65	5	10
160	160 0004 010	4	7,50	65	5	10
160	160 0045 010	4,5	7,50	65	5	10
160	160 0005 010	5	7,50	65	6	10
160	160 0055 010	5,5	7,50	75	6	10
160	160 0006 010	6	7,50	75	6	10
160	160 0007 010	7	7,50	90	8	10
160	160 0008 010	8	7,50	90	15	10
160	160 0009 010	9	7,60	100	17	10
160	160 0010 010	10	7,60	100	20	10
160	160 0011 010	11	7,60	115	28	10
160	160 0012 010	12	8,10	115	28	10
160	160 0013 010	13	8,35	130	35	10
160	160 0014 010	14	8,65	130	35	10

Amerikanische Zollmaße AF"

AF"

Artikel-Nr. Order-No.	Ident-Nr. Ident-No.	AF"	€	L		
160	160 8106 010	5/32	7,60	65	5	10
160	160 8107 010	3/16	7,60	65	5	10
160	160 8111 010	1/4	7,60	75	6	10
160	160 8115 010	5/16	7,60	90	8	10
160	160 8117 010	11/32	7,60	100	18	10
160	160 8118 010	3/8	7,60	100	18	10
160	160 8120 010	7/16	8,10	115	28	10
160	160 8122 010	1/2	8,50	130	35	10
160	160 8124 010	9/16	9,25	130	35	10

Satz in Kunstleder-Tasche

Set in plastic bag

160

Artikel-Nr. Order-No.	Ident-Nr. Ident-No.	€	Inhalt Content	mm		
160/10	160 0106 010	75,00	3,2, 3,5, 4, 4,5, 5, 5,5, 6, 7, 8, 9		180	1
160/15	160 0156 010	108,00	3,2, 3,5, 4, 4,5, 5, 5,5, 6, 7, 8, 9, 10, 11, 12, 13, 14		360	1

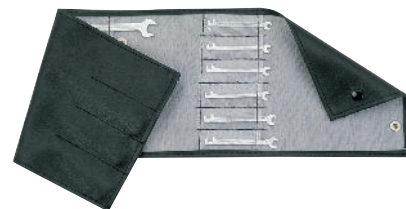

Amerikanische Zollmaße AF"

AF"

Artikel-Nr. Order-No.	Ident-Nr. Ident-No.	€	Inhalt Content	AF"		
160/9	160 0096 010	75,00	5/32, 3/16, 1/4, 5/16, 11/32, 3/8, 7/16, 1/2, 9/16		170	1

Verstellbare Einmaulschlüssel

Adjustable single ended spanner

DIN 3117 Form B – ISO 6787

DIN 3117 Form B – ISO 6787

Form Crescent, Chrom-Vanadium-Stahl, verchromt,

form CRESCENT, chrome vanadium steel, chrome

Kopf hochglanzpoliert

plated, head mirror polished

210



Artikel-Nr. Order-No.	Ident-Nr. Ident-No.	Größe Size	mm max.	€	L		
210	03858	4"	14	17,30	110	50	5
210	03868	6"	20	18,15	160	105	5
210	03878	8"	25	21,40	210	220	5
210	03888	10"	29	26,90	260	390	5
210	03898	12"	34	35,75	310	650	5
210	03908	15"	44	61,90	380	1170	1
210	03918	18"	53	96,70	460	2100	1

Schraubenschlüssel Spanners & wrenches

280 C



Ring-Maulschlüssel **ENERGY**

DIN 3113 Form A – ISO 3318

kurze Ausführung, Ringseite 15° abgewinkelt,
Chrom-Vanadium-Stahl, verchromt, Köpfe geschliffen,
alle mm-Größen mit **ENERGY**-Profil auf der Ringseite

Combination spanner **ENERGY**

DIN 3113 Form A – ISO 3318

short pattern, ring end 15° angled, chrome vanadium
steel, chrome plated, heads smoothly grinded,
all mm-sizes with **ENERGY**-profile at ring end

Artikel-Nr. Order-No.	Ident-Nr. Ident-No.	mm	€	L	⚖️	📄
280 C	05012	6	5,40	100	14	10
280 C	05022	7	5,40	110	19	10
280 C	05032	8	5,55	120	26	10
280 C	05042	9	5,80	130	32	10
280 C	05052	10	5,40	140	39	10
280 C	05062	11	5,85	150	49	10
280 C	05072	12	6,80	160	58	10
280 C	05082	13	6,90	170	89	10
280 C	05092	14	7,60	180	84	10
280 C	05102	15	8,25	190	97	10
280 C	05112	16	8,25	200	105	10
280 C	05122	17	9,75	210	130	10
280 C	05132	18	10,10	210	125	10
280 C	05142	19	10,80	230	180	10
280 C	05152	20	11,15	230	188	10
280 C	05162	21	11,50	240	203	10
280 C	05172	22	12,95	260	249	10
280 C	05182	23	13,90	260	215	5
280 C	05192	24	15,90	280	280	5
280 C	05202	25	16,95	280	260	5
280 C	05212	26	18,80	300	302	5
280 C	05222	27	18,80	300	380	5
280 C	05232	28	19,44	300	357	5
280 C	05242	30	22,70	332	472	5
280 C	05252	32	26,05	360	555	5
280 C	04992	34	32,60	380	690	3
280 C	05262	36	32,60	380	670	3

Amerikanische Zollmaße AF"

ohne **ENERGY**-profil

AF"

without **ENERGY**-profil

Artikel-Nr. Order-No.	Ident-Nr. Ident-No.	AF"	€	L	⚖️	📄
280 C	05352	1/4	6,30	100	20	10
280 C	05362	5/16	6,60	120	27	10
280 C	05372	3/8	6,75	130	32	10
280 C	05382	7/16	6,75	150	49	10
280 C	05392	1/2	7,20	170	89	10
280 C	05402	9/16	7,95	180	82	10
280 C	05412	5/8	9,20	200	122	10
280 C	05422	11/16	10,45	210	125	10
280 C	05432	3/4	11,50	230	174	10
280 C	05442	13/16	12,40	240	203	10
280 C	05452	7/8	14,10	260	226	10
280 C	05462	15/16	17,10	280	303	5
280 C	05472	1	17,10	280	280	5
280 C	05482	1 1/16	21,20	300	358	5
280 C	05492	1 1/8	23,80	300	489	5
280 C	05502	1 1/4	28,25	360	491	5

280 C



Satz in Karton **ENERGY**

Set in carton **ENERGY**

Artikel-Nr. Order-No.	Ident-Nr. Ident-No.	€	Inhalt Content	mm	⚖️	📄
280/8 C	05002	63,50	8, 10, 11, 13, 14, 17, 19, 22		850	1
280/12 C	05322	45,00	8, 9, 10, 11, 12, 13, 14, 15, 17, 19, 21, 22		1485	1
280/120 C	05332	86,00	6, 7, 8, 9, 10, 11, 12, 13, 14, 17, 19, 22		950	1
280/16 C	05342	176,00	8, 9, 10, 11, 12, 13, 14, 15, 17, 19, 21, 22, 24, 27, 30, 32		3175	1

Amerikanische Zollmaße AF"

ohne **ENERGY**-profil

AF"

without **ENERGY**-profil

Artikel-Nr. Order-No.	Ident-Nr. Ident-No.	€	Inhalt Content	AF"	⚖️	📄
280/9 C	05552	60,00	1/4, 5/16, 3/8, 7/16, 1/2, 9/16, 5/8, 11/16, 3/4		720	1
280/16 C	05572	200,00	1/4, 5/16, 3/8, 7/16, 1/2, 9/16, 5/8, 11/16, 3/4, 13/16, 7/8, 15/16, 1, 1 1/16, 1 1/8, 1 1/4		3070	1

Ratschfix ENERGY

ratschender Maul-Ringschlüssel,
Ring mit ENERGY-Profil 15° abgewinkelt,
Länge nach DIN 3113 A Chrom-Vanadium-Stahl,
verchromt, Köpfe geschliffen, Super-Finish

Combination spanner ENERGY

with ratcheting open end,
ring with ENERGY-profile, 15° angled, length as per DIN
3113 A, chrome vanadium steel, chrome plated, heads
smoothly grinded, Super-Finish

Artikel-Nr. Order-No.	Ident-Nr. Ident-No.	mm	€	L	⚖	📄
280 R	275 0080 020	8	7,10	120	26	10
280 R	275 0090 020	9	7,10	130	32	10
280 R	275 0100 020	10	8,40	140	39	10
280 R	275 0110 020	11	8,65	150	49	10
280 R	275 0120 020	12	9,15	160	59	10
280 R	275 0130 020	13	9,25	170	69	10
280 R	275 0140 020	14	10,60	180	84	10
280 R	275 0150 020	15	10,90	190	97	10
280 R	275 0160 020	16	11,50	200	105	10
280 R	275 0170 020	17	11,70	210	120	10
280 R	275 0180 020	18	12,80	210	145	10
280 R	275 0190 020	19	13,55	230	160	10
280 R	275 0210 020	21	14,40	240	200	5
280 R	275 0220 020	22	16,15	260	235	5
280 R	275 0240 020	24	18,40	280	275	5
280 R	275 0270 020	27	21,75	300	360	5
280 R	275 0280 020	28	23,40	300	375	5
280 R	275 0300 020	30	28,75	330	450	5

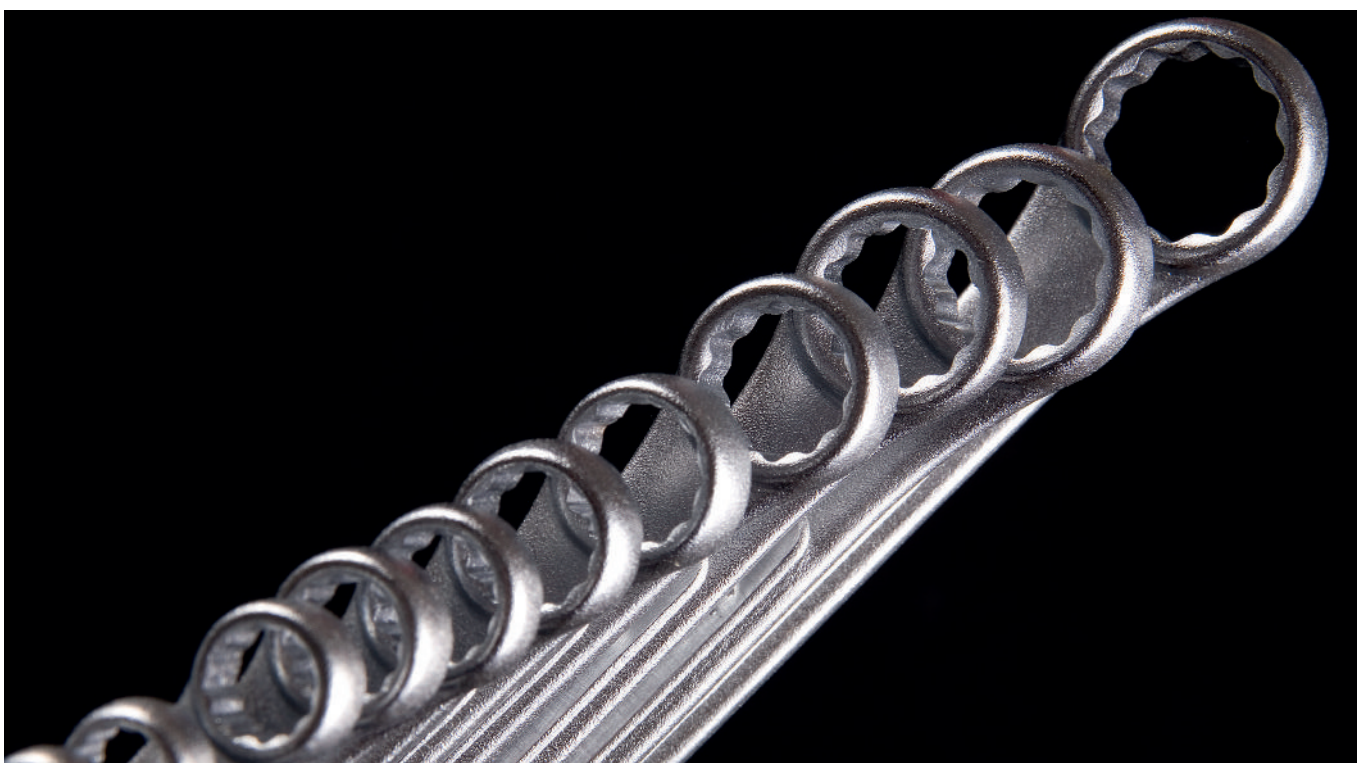
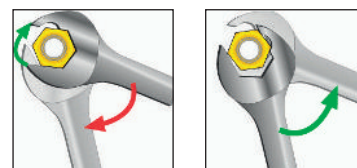
280 R

Ringschlüssel, gerade
ring spanner, straight

Schraubenschlüssel Spanners & wrenches

290 C



Ring-Maulschlüssel **ENERGY**

DIN 3113 Form B – ISO 3318

lange Ausführung, Ringseite 15° gekröpft,
Chrom-Vanadium-Stahl, verchromt, Köpfe geschliffen,
alle mm-Größen mit **ENERGY**-Profil auf der Ringseite
(bis 41 mm)

Combination spanner **ENERGY**

DIN 3113 Form B – ISO 3318

long pattern, ring end 15° offset, chrome vanadium
steel, chrome plated, heads smoothly grinded,
ENERGY-profile at ring end (up to 41 mm)

Artikel-Nr. Order-No.	Ident-Nr. Ident-No.	mm	€	L		
290 C	05952	6	5,40	110	21	10
290 C	05962	7	5,40	120	23	10
290 C	05722	8	5,40	130	30	10
290 C	05732	9	5,40	140	36	10
290 C	05742	10	5,40	150	45	10
290 C	05752	11	5,85	160	54	10
290 C	05762	12	6,80	170	62	10
290 C	05772	13	6,86	175	74	10
290 C	05782	14	7,60	185	90	10
290 C	05792	15	8,25	195	101	10
290 C	05802	16	8,60	210	122	10
290 C	05812	17	9,75	230	144	10
290 C	05822	18	10,00	240	155	10
290 C	05832	19	10,80	250	186	10
290 C	05842	20	11,25	250	214	10
290 C	05852	21	12,80	285	276	10
290 C	05862	22	13,20	285	293	10
290 C	05872	23	14,10	330	273	5
290 C	05882	24	17,30	330	392	5
290 C	05892	25	20,45	355	453	5
290 C	05902	26	20,45	355	442	5
290 C	05912	27	22,55	360	486	5
290 C	05922	28	22,75	360	458	5
290 C	05932	30	25,80	395	637	5
290 C	05942	32	30,20	435	755	5
290 C	05702	34	43,35	435	983	3
290 C	05972	36	43,35	470	952	3
290 C	05982	41	57,60	475	1339	1

vernickelt **ENERGY**

nickel plated **ENERGY**

Artikel-Nr. Order-No.	Ident-Nr. Ident-No.	mm	€	L		
290 C	05283	46	94,50	520	1752	1
290 C	05293	50	116,20	560	2100	1
290 C	05303	55	162,90	610	2860	1
290 C	05313	60	222,70	660	3420	1
290 C	05523	65	270,50	710	4550	1
290 C	05533	70	298,80	760	5800	1
290 C	05543	75	356,50	810	6650	1
290 C	05553	80	424,50	860	7500	1

290 C



Satz in Karton **ENERGY**

Set in carton **ENERGY**



Artikel-Nr. Order-No.	Ident-Nr. Ident-No.	€	Inhalt Content	mm		
290/8 C	4952	64,00	8, 10, 11, 13, 14, 17, 19, 22		915	1
290/12 C	4962	95,50	8, 9, 10, 11, 12, 13, 14, 15, 17, 19, 21, 22		1390	1
290/16 C	4982	192,00	8, 9, 10, 11, 12, 13, 14, 15, 17, 19, 21, 22, 24, 27, 30, 32		3660	1

Doppelringschlüsse **ENERGY** 
 DIN 837 B – ISO 3318
 gerade, Chrom-Vanadium-Stahl, verchromt,
 Ringe geschliffen, **ENERGY**-Profil

Double ended ring spanner **ENERGY** 
 DIN 837 B – ISO 3318
 straight, chrome vanadium steel, chrome plated,
 rings smoothly grinded, **ENERGY**-profile

360 C





Artikel-Nr. Order-No.	Ident-Nr. Ident-No.	mm	€	L		
360 C	06521	6 x 7	5,00	97	12	10
360 C	06531	8 x 9	5,15	115	16	10
360 C	06541	8 x 10	4,65	115	19	10
360 C	06551	9 x 11	7,30	125	25	10
360 C	06561	10 x 11	4,05	125	27	10
360 C	06571	10 x 13	5,45	140	33	10
360 C	06591	11 x 13	5,45	140	33	10
360 C	06611	12 x 13	4,95	140	40	10
360 C	06621	12 x 14	5,45	145	40	10
360 C	06601	13 x 14	5,45	150	46	10
360 C	06631	13 x 15	5,95	155	46	10
360 C	06861	13 x 16	7,35	155	46	10
360 C	06641	14 x 15	5,45	155	50	10
360 C	06651	13 x 17	5,94	170	67	10
360 C	06661	14 x 17	6,64	170	65	10
360 C	06671	16 x 17	6,55	170	70	10
360 C	06681	16 x 18	6,70	170	65	10
360 C	06691	17 x 19	7,20	185	84	10
360 C	06701	18 x 19	7,35	190	83	10
360 C	06881	18 x 21	10,45	200	128	10
360 C	06711	19 x 22	8,70	200	124	10
360 C	06721	20 x 22	8,65	200	120	10
360 C	06731	21 x 23	10,55	215	142	5
360 C	06921	21 x 24	11,50	215	144	5
360 C	06741	22 x 24	9,80	215	144	5
360 C	06761	24 x 26	11,50	255	201	5
360 C	06771	24 x 27	11,30	255	199	5
360 C	06781	25 x 28	12,50	265	217	5
360 C	06801	27 x 32	17,40	280	260	5
360 C	06811	30 x 32	15,95	285	292	5
360 C	06941	30 x 34	25,55	330	380	5
360 C	06821	30 x 36	21,75	330	380	3
360 C	06831	32 x 36	24,55	330	427	3

Satz in Karton **ENERGY** 

Set in carton **ENERGY** 

360 C

Artikel-Nr. Order-No.	Ident-Nr. Ident-No.	€	Inhalt Content	mm		
360/8 C	06871	46,50	6x7, 8x9, 10x11, 12x13, 14x15, 16x17, 18x19, 20x22		420	1
360/12 C	06901	97,00	6x7, 8x9, 10x11, 12x13, 14x15, 16x17, 18x19, 20x22, 21x23, 24x27, 25x28, 30x32		1270	1



Schraubenschlüssel Spanners & wrenches

380 C



Doppelringschlüssel **ENERGY**

DIN 838 – ISO 3318

gekröpft, Chrom-Vanadium-Stahl, verchromt, Ringe geschliffen, mm-Größen mit **ENERGY**-Profil

Double ended ring spanner **ENERGY**

DIN 838 – ISO 3318

offset, chrome vanadium steel, chrome plated, rings smoothly grinded, mm-sizes with **ENERGY**-profile

Artikel-Nr. Order-No.	Ident-Nr. Ident-No.	mm	€	L		
380 C	07301	6 x 7	5,30	175	53	10
380 C	07281	7 x 8	7,60	179	55	10
380 C	07311	8 x 9	5,60	179	70	10
380 C	07321	8 x 10	5,30	185	69	10
380 C	07331	9 x 11	5,95	193	84	10
380 C	07341	10 x 11	5,40	197	84	10
380 C	07361	10 x 13	6,40	220	111	10
380 C	07381	11 x 13	6,70	218	117	10
380 C	07401	12 x 13	6,30	222	113	10
380 C	07411	12 x 14	6,70	225	125	10
380 C	07421	13 x 14	6,60	224	152	10
380 C	07431	13 x 15	7,45	225	161	10
380 C	07441	14 x 15	7,45	230	157	10
380 C	07741	13 x 16	8,65	248	183	10
380 C	07451	13 x 17	8,65	245	186	10
380 C	07461	14 x 17	8,65	248	182	10
380 C	07471	16 x 17	8,80	251	199	10
380 C	07481	16 x 18	8,95	251	211	10
380 C	07491	17 x 19	10,15	290	257	10
380 C	07501	18 x 19	10,15	285	266	10
380 C	07291	18 x 21	14,10	285	322	10
380 C	07511	19 x 22	11,90	297	295	10
380 C	07521	20 x 22	12,15	300	324	10
380 C	07531	19 x 24	12,40	311	350	5
380 C	07541	21 x 23	12,45	315	356	5
380 C	07821	21 x 24	14,70	312	384	5
380 C	07551	22 x 24	14,90	312	379	5
380 C	07561	24 x 26	15,70	335	437	5
380 C	07571	24 x 27	15,55	324	474	5
380 C	07581	24 x 30	18,15	343	587	5
380 C	07591	25 x 28	18,50	340	577	5
380 C	07601	27 x 30	19,55	343	600	5
380 C	07611	27 x 32	21,10	383	639	5
380 C	07621	30 x 32	23,55	383	623	5
380 C	07761	30 x 34	27,20	400	643	3
380 C	07631	30 x 36	28,25	400	810	3
380 C	07831	32 x 34	32,60	395	790	3
380 C	07641	32 x 36	28,60	395	790	3
380 C	07841	34 x 36	32,60	395	862	3
380 C	07651	36 x 41	41,80	445	1200	3
380 C	07661	41 x 46	65,15	490	1500	1
380 C	07671	46 x 50	86,90	535	1900	1

vernickelt **ENERGY**

nickel plated **ENERGY**

Artikel-Nr. Order-No.	Ident-Nr. Ident-No.	mm	€	L		
380 C	07683	55 x 60	172,00	610	3775	1
380 C	07693	65 x 70	276,00	685	5410	1
380 C	07703	75 x 80	354,00	790	7100	1
380 C	07713	85 x 90	395,00	800	6800	1

Amerikanische Zollmaße AF"

ohne **ENERGY**-profil

AF"

without **ENERGY**-profil

Artikel-Nr. Order-No.	Ident-Nr. Ident-No.	AF"	€	L		
380 C	07851	1/4 x 5/16	5,80	153	53	10
380 C	07861	5/16 x 3/8	6,20	183	71	10
380 C	07871	3/8 x 7/16	5,40	195	80	10
380 C	07881	7/16 x 1/2	6,50	194	123	10
380 C	07891	1/2 x 9/16	7,25	222	144	10
380 C	07901	9/16 x 5/8	8,35	215	182	10
380 C	07911	5/8 x 11/16	9,85	252	199	10
380 C	07921	5/8 x 3/4	9,60	250	225	10
380 C	07931	11/16 x 3/4	9,85	281	257	10
380 C	07941	3/4 x 7/8	11,85	229	318	10
380 C	07951	13/16 x 7/8	11,85	229	347	10
380 C	07961	15/16 x 1	14,85	331	459	5
380 C	07971	1 x 1 1/8	18,65	345	583	5
380 C	07981	1 1/16 x 1 1/4	19,55	364	649	5
380 C	07991	1 1/4 x 1 7/16	27,65	409	824	1
380 C	08001	1 7/16 x 1 5/8	49,60	440	1240	1

Satz in Karton **ENERGY**

Set in carton **ENERGY**

380 C

Artikel-Nr. Order-No.	Ident-Nr. Ident-No.	€	Inhalt Content	mm		
380/6 C	07751	38,50	6x7, 8x9, 10x11, 12x13, 14x15, 16x17		675	I
380/8 C	07771	61,00	6x7, 8x9, 10x11, 12x13, 14x15, 16x17, 18x19, 20x22		1400	I
380/10 C	07791	89,00	6x7, 8x9, 10x11, 12x13, 14x15, 16x17, 18x19, 20x22, 21x23, 24x27		2095	I
380/12 C	07801	130,00	6x7, 8x9, 10x11, 12x13, 14x15, 16x17, 18x19, 20x22, 21x23, 24x27, 25x28, 30x32		3295	I



Amerikanische Zollmaße AF^o
ohne **ENERGY**-profil

AF^o
without **ENERGY**-profil

Artikel-Nr. Order-No.	Ident-Nr. Ident-No.	€	Inhalt Content	AF ^o		
380/6 C	08031	60,00	1/4 x 5/16, 3/8 x 7/16, 1/2 x 9/16, 5/8 x 3/4, 13/16 x 7/8, 15/16 x 1		1310	I
380/8 C	08041	91,00	1/4 x 5/16, 5/16 x 3/8, 7/16 x 1/2, 9/16 x 5/8, 11/16 x 3/4, 13/16 x 7/8, 15/16 x 1, 1 1/16 x 1 1/4		2140	I
380/12 C	08051	189,00	1/4 x 5/16, 5/16 x 3/8, 3/8 x 7/16, 7/16 x 1/2, 1/2 x 9/16, 9/16 x 5/8, 11/16 x 3/4, 13/16 x 7/8, 15/16 x 1, 1 1/16 x 1 1/4, 1 1/4 x 1 7/16, 1 7/16 x 1 5/8		4430	I

Satz in Sichtkarton **ENERGY**

Set in display carton **ENERGY**

380 C

Artikel-Nr. Order-No.	Ident-Nr. Ident-No.	€	Inhalt Content	mm		
380/8 C	380 0083 010	62,00	6x7, 8x9, 10x11, 12x13, 14x15, 16x17, 18x19, 20x22		1350	I



Ringschlüssel, gekröpft
ring spanner, offset

Schraubenschlüssel Spanners & wrenches

350 C



Doppel-Gelenksteckschlüssel
Chrom-Vanadium-Stahl, verchromt, Köpfe poliert

Double ended swivel head spanner
chrome vanadium steel, chrome plated, heads polished

Artikel-Nr. Order-No.	Ident-Nr. Ident-No.	mm	€	L		
350 C	06291	8 x 9	21,60	175	65	10
350 C	06301	10 x 11	22,80	195	100	10
350 C	06311	12 x 13	24,95	210	145	10
350 C	06321	13 x 17	26,65	225	210	10
350 C	06331	14 x 15	26,65	225	210	10
350 C	06341	16 x 17	30,40	245	270	10
350 C	06271	16 x 18	32,60	245	270	10
350 C	06351	17 x 19	34,30	280	360	10
350 C	06361	18 x 19	34,30	260	360	10

350 C



Satz in Karton

Set in carton

Artikel-Nr. Order-No.	Ident-Nr. Ident-No.	€	Inhalt Content	mm		
350/6 C	06410	157,50	8x9, 10x11, 12x13, 14x15, 16x18, 17x19,	1150	1	

370 C



Offener Ringschlüssel
DIN 3118
für Überwurfmutter und Rohrleitungsverschraubungen, Chrom-Vanadium-Stahl, verchromt,
Köpfe geschliffen

Open ended ring spanner
DIN 3118
for all union nuts and tube lines, chrome vanadium
steel, chrome plated, heads smoothly grinded

Artikel-Nr. Order-No.	Ident-Nr. Ident-No.	mm	€	L		
370 C	07182	8 x 10	13,00	150	55	5
370 C	07192	9 x 11	13,55	150	55	5
370 C	07202	10 x 11	13,55	155	65	5
370 C	07201	11 x 13	13,55	175	80	5
370 C	07210	12 x 14	15,90	175	80	5
370 C	07213	13 x 15	16,25	175	90	5
370 C	07232	14 x 17	16,35	200	135	5
370 C	07231	16 x 18	18,50	215	175	5
370 C	07221	17 x 19	18,50	215	175	5
370 C	07242	19 x 22	22,30	215	210	5
370 C	07251	22 x 24	28,80	240	240	1
370 C	07262	24 x 27	29,35	255	290	1
370 C	07271	30 x 32	38,10	280	320	1

390 C



Doppelringschlüssel
für Außen-TORX-Schrauben, Chrom-Vanadium-Stahl,
verchromt, Köpfe poliert

Double ended ring spanner
for exterior TORX head screws, chrome vanadium
steel, chrome plated, heads polished

Artikel-Nr. Order-No.	Ident-Nr. Ident-No.	Nr. No.	in mm	€	L		
390 C	07092	E 6 x E 8	8 x 10	10,50	115	14	1
390 C	07102	E 10 x E 12	9 x 11	12,80	144	25	1
390 C	07112	E 14 x E 18	10 x 11	16,90	179	55	1
390 C	07122	E 20 x E 24	30 x 32	21,70	226	155	1

390 C





Satz in Karton

Set in carton

Artikel-Nr. Order-No.	Ident-Nr. Ident-No.	€	Inhalt Content	mm		
390/4 C	07132	62,50	E6 x E8, E10 x E12, E14 x E18, E20 x E24	250	1	

Starter- und Blockschlüssel **ENERGY** 
 Chrom-Vanadium-Stahl, verchromt, Ringe geschliffen,
 mm-Größen mit **ENERGY**-Profil

Starter and block spanner **ENERGY** 
 chrome vanadium steel, chrome plated, rings smoothly
 grinded, mm-sizes with **ENERGY** profile

Artikel-Nr. Order-No.	Ident-Nr. Ident-No.	mm	€	L		
420 C	08431	11 x 13	9,00	145	77	10
420 C	08441	12 x 13	9,00	145	77	10
420 C	08451	13 x 15	11,40	165	101	10
420 C	08461	14 x 17	11,80	185	155	10
420 C	08471	19 x 22	16,00	235	261	10





Amerikanische Zollmaße AF"
 ohne **ENERGY**-profil

AF"
 without **ENERGY** profile

Artikel-Nr. Order-No.	Ident-Nr. Ident-No.	AF"	€	L		
420 C	08481	7/16 x 1/2	9,00	145	77	10
420 C	08491	1/2 x 9/16	9,00	165	99	10
420 C	08501	9/16 x 5/8	11,70	185	153	10
420 C	08511	3/4 x 7/8	16,00	235	279	1

Doppel-Steckschlüssel 
 massiv, Chrom-Vanadium-Stahl, geschmiedet und
 durchgehend gebohrt, verchromt,
 Verwendung mit Drehstift



Double ended box wrench 
 solid pattern, chrome vanadium steel, forged and
 bored through, chrome plated, use with tommy bar

Artikel-Nr. Order-No.	Ident-Nr. Ident-No.	mm	€	Drehstift Ø tommy bar	L		
1130	15111	6 x 7	11,60	3	100	30	10
1130	15121	8 x 9	11,70	3	108	50	10
1130	15131	10 x 11	13,75	5	116	70	10
1130	15141	12 x 13	14,30	5	124	100	10
1130	15151	14 x 15	15,00	6	132	120	10
1130	15161	16 x 17	16,65	8	140	160	10
1130	15171	17 x 19	19,45	8	148	195	10
1130	15181	18 x 19	19,45	8	148	195	10
1130	15191	20 x 22	21,75	10	156	255	10
1130	15201	21 x 23	22,90	10	163	300	5
1130	15211	24 x 27	26,60	10	173	390	5
1130	15221	25 x 28	29,30	10	182	460	5
1130	15231	30 x 32	38,40	12	200	620	5



Satz in Karton
 mit Drehstiften 1085/1 - 1090/3 - 1090/5

Set in carton
 with tommy bar 1085/1 - 1090/3 - 1090/5

Artikel-Nr. Order-No.	Ident-Nr. Ident-No.	€	Inhalt Content	mm		
1130 / 8	15281	150,00	6x7, 8x9, 10x11, 12x13, 14x15, 16x17, 18x19, 20x22		1250	1
1130 / 12	15291	278,00	6x7, 8x9, 10x11, 12x13, 14x15, 16x17, 18x19, 20x22, 21x23, 24x27, 25x28, 30x32		3200	1



420 C

1130

1130

Schraubenschlüssel Spanners & wrenches

1080 N



Rohrsteckschlüssel

DIN 896 Form B – ISO 2236 / ISO 1085

doppelseitig, aus nahtlos kaltgezogenem Präzisions-Stahlrohr, gehärtet, vernickelt, Verwendung mit Drehstift

Tubular box wrench

DIN 896 Form B – ISO 2236 / ISO 1085

Double ended, seamless drawn steel tube, hardened, nickel plated, use with tommy bar

Artikel-Nr. Order-No.	Ident-Nr. Ident-No.	↕ mm	€	Drehstift Ø tommy bar	L	⚖	📄
1080 N	I4313	6 × 7	3,50	5	100	30	10
1080 N	I4303	7 × 8	3,95	5	100	30	10
1080 N	I4323	8 × 9	3,95	5	105	35	10
1080 N	I4333	8 × 10	4,05	5	120	45	10
1080 N	I4343	9 × 10	4,05	6	120	45	10
1080 N	I4353	9 × 11	4,05	6	120	55	10
1080 N	I4363	10 × 11	4,05	6	120	55	10
1080 N	I4373	10 × 13	4,90	6	120	80	10
1080 N	I4383	11 × 13	4,90	6	135	85	10
1080 N	I4403	12 × 13	4,90	6	135	85	10
1080 N	I4413	12 × 14	4,75	6	140	85	10
1080 N	I4423	13 × 15	4,75	8	140	90	10
1080 N	I4093	13 × 16	6,20	8	140	90	10
1080 N	I4433	14 × 15	4,75	8	140	90	10
1080 N	I4443	13 × 17	5,35	8	150	130	10
1080 N	I4453	14 × 17	5,35	8	150	130	10
1080 N	I4463	16 × 17	5,35	10	150	130	10
1080 N	I4103	16 × 18	8,30	10	150	135	10
1080 N	I4473	17 × 19	7,85	10	160	195	10
1080 N	I4483	18 × 19	8,05	10	160	195	10
1080 N	I4493	19 × 22	8,05	12	165	220	10
1080 N	I4503	20 × 22	8,05	12	165	220	10
1080 N	I4513	21 × 23	8,60	12	170	225	5
1080 N	I4523	19 × 24	9,50	12	185	300	5
1080 N	I4533	22 × 24	9,50	14	185	300	5
1080 N	I4543	24 × 26	9,80	14	185	300	5
1080 N	I4553	24 × 27	9,80	14	185	300	5
1080 N	I4563	24 × 30	11,65	14	205	380	5
1080 N	I4573	25 × 28	11,65	14	205	350	5
1080 N	I4583	27 × 30	12,15	16	205	380	5
1080 N	I4603	30 × 32	13,15	16	205	410	5
1080 N	I4113	30 × 34	16,35	16	205	500	1
1080 N	I4613	30 × 36	15,25	16	220	530	1
1080 N	I4623	32 × 36	15,40	16	220	530	1
1080 N	I4633	36 × 41	18,60	18	220	700	1
1080 N	I4643	41 × 46	26,45	18	245	800	1
1080 N	I4123	46 × 50	44,95	18	250	1250	1
1080 N	I4133	50 × 55	57,05	18	250	1670	1

1080



Satz in Karton
ohne Drehstift

Set in carton
without tommy bar

Artikel-Nr. Order-No.	Ident-Nr. Ident-No.	€	Inhalt Content	↕ mm	⚖	📄
1080 / 8	I4673	44,20	6x7, 8x9, 10x11, 12x13, 14x15, 16x17, 18x19, 20x22		890	1
1080 / 12	I4683	84,60	6x7, 8x9, 10x11, 12x13, 14x15, 16x17, 18x19, 20x22, 21x23, 24x27, 25x28, 30x32		2500	1

Stufendrehstift
vernickelt

Tommy bar
nickel plated

1085



Artikel-Nr. Order-No.	Ident-Nr. Ident-No.	€	Ø	L		
1085/1	14703	11,85	6, 8, 10, 12, 14	250	240	5
1085/2	14704	11,85	3, 3.5, 4.5, 5.5, 6	180	35	5
1085/3	14705	12,40	7, 8, 9, 10, 12, 13	280	260	5

Drehstift
DIN 900 A
phosphatiert

Tommy bar
DIN 900 A
phosphatiert

1090 PH



Artikel-Nr. Order-No.	Ident-Nr. Ident-No.	€	Ø	L		
1090 PH	14734	1,40	3	110	5	5
1090 PH	14744	1,45	5	125	15	5
1090 PH	14754	1,55	6	160	35	5
1090 PH	14764	1,75	8	180	70	5
1090 PH	14774	2,60	10	200	115	5
1090 PH	14784	3,90	12	250	210	5
1090 PH	14794	5,35	14	320	380	5
1090 PH	14804	9,25	16	400	620	1
1090 PH	14814	15,85	18	500	1000	1

Dreikant-Rohrsteckschlüssel
DIN 22417

aus nahtlos kaltgezogenem Präzisions-Stahlrohr,
mit durchgestecktem, beweglichem Quergriff, verzinkt

Three-square tubular wrench
DIN 22417

made of seamless drawn steel tube with movable
T-handle, zinc plated

1100 Z

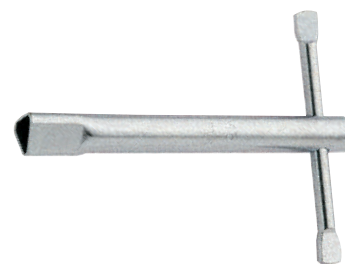

Artikel-Nr. Order-No.	Ident-Nr. Ident-No.	€	Inhalt Content		L		
1100 Z	14839	3,40	M 4		90	25	10
1100 Z	14849	3,65	M 5		100	35	10
1100 Z	14859	3,80	M 6		110	65	5
1100 Z	14869	3,90	M 8		125	85	5
1100 Z	14879	4,70	M 10		140	170	5
1100 Z	14889	5,60	M 12		162	250	1
1100 Z	14899	7,85	M 16		180	450	1

Phosphatierte Werkzeuge

Was heißt „phosphatieren“?

Unter „phosphatieren“ verstehen wir die Behandlung von Metalloberflächen mit speziellen phosphathaltigen Lösungen. Wir verwenden ein hochwertiges Zinkphosphat, das eine besonders feinkristalline Oberflächenstruktur erzeugt. Metalloberfläche und Phosphatschicht gehen dabei eine dauerhafte, auf mechanischem Wege untrennbare Verbindung ein. Durch weitere Bäder nach dem Phosphatieren werden die feinen Poren gesättigt und ein dauerhafter Korrosionsschutz erreicht.

Warum „phosphatierte Werkzeuge“?

- Das „Phosphatieren“ ist ein umweltschonender Produktionsvorgang.
- Phosphatierte Oberflächen sind dauerhaft gegen Korrosion geschützt.
- Die Phosphatierung ist widerstandsfähig gegen Schlägeinwirkung. Keine Gefahr des Abplatzens oder Abblätterns. Deshalb verwenden wir phosphatierte Werkzeuge bei Kraft-Einsätzen und hochwertigen Schlagschlüsseln.
- Unsere phosphatierten Werkzeuge sind bei gleicher Material- und Verarbeitungsqualität deutlich preiswerter als die entsprechenden Artikel in verchromter Ausführung.

Phosphatized tools

What means „phosphatized“?

„Phosphatizing“ means treatment of metal surfaces with special phosphate liquids. We use a high-quality zinc phosphate that produces a specially fine crystalline surface structure. Metal surface and phosphate undergo a chemical metallurgical bonding which is unseparable by mechanical means. By further bathes after phosphatizing the fine pores are saturated and a permanent protection against corrosion is reached.

Why use phosphatized tools?

- phosphatizing is an environmental protecting production method.
- phosphated surfaces are permanently protected against corrosion.
- phosphated surfaces are resistant against impacts. No danger of chipping or peeling off. That's why we use this surface treatment on impact sockets and high-quality slugging spanners.
- prices of our phosphatized tools are considerably lower than the corresponding items in chrome plated version, but offering the same quality in material and workmanship.

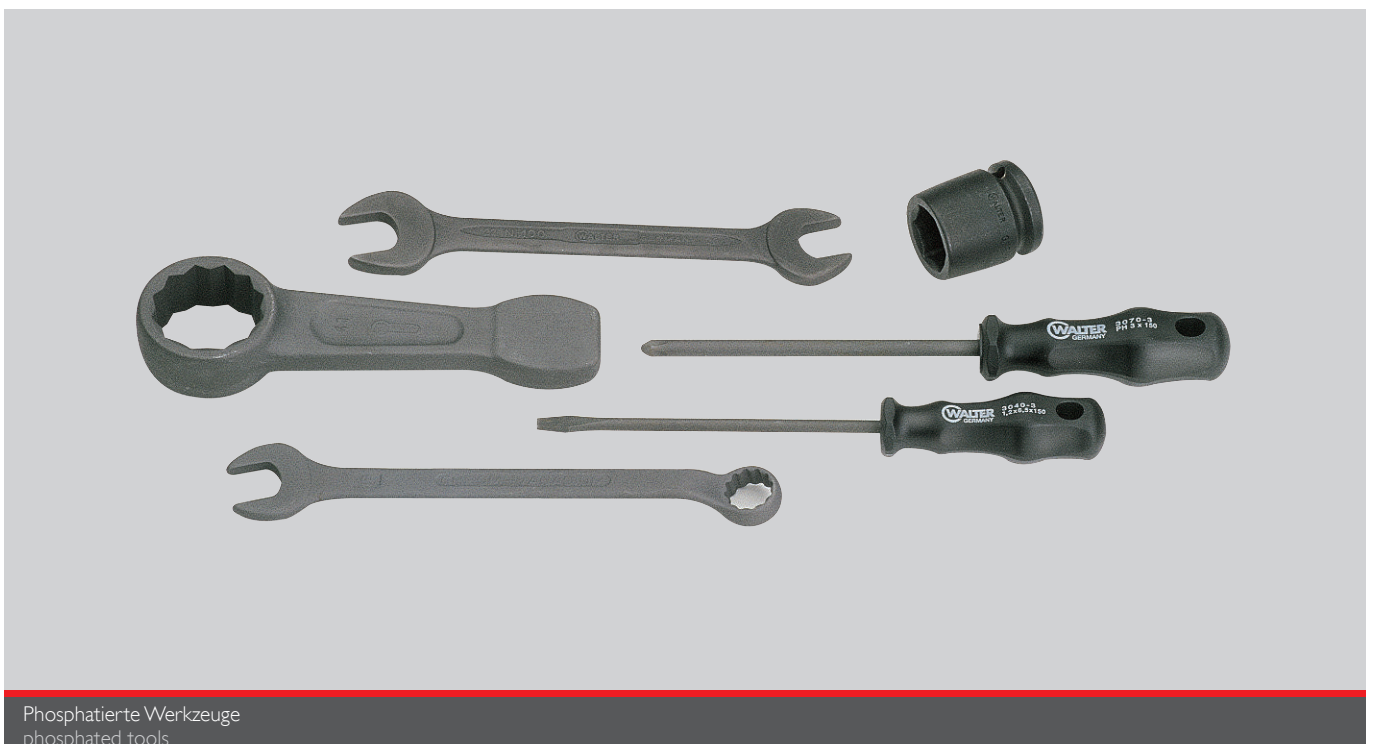

Phosphatierte Werkzeuge
phosphated tools

Doppelmaulschlüssel
DIN 3110 – ISO 3318/ISO 1085
Chrom-Vanadium-Stahl, phosphatiert,
Maulstellung 15°

Double open ended spanner
DIN 3110 – ISO 3318/ISO 1085
chrome vanadium steel, phosphatized,
position of open ends 15°

100 PH



Artikel-Nr. Order-No.	Ident-Nr. Ident-No.	mm	€	L		
100 PH	00054	4 x 5	5,35	110	16	10
100 PH	00094	6 x 7	1,75	123	22	10
100 PH	00104	7 x 8	2,00	132	30	10
100 PH	00124	8 x 9	1,95	143	30	10
100 PH	00134	8 x 10	2,15	143	30	10
100 PH	00154	9 x 11	2,45	157	46	10
100 PH	00164	10 x 11	2,40	157	48	10
100 PH	00174	10 x 12	2,43	157	45	10
100 PH	00184	10 x 13	5,00	171	64	10
100 PH	00194	11 x 13	3,25	171	69	10
100 PH	00204	12 x 13	3,05	172	64	10
100 PH	00224	12 x 14	3,25	180	69	10
100 PH	00234	13 x 14	3,56	180	81	10
100 PH	00244	13 x 15	3,60	190	88	10
100 PH	00254	14 x 15	3,60	190	88	10
100 PH	00034	13 x 16	5,15	190	100	10
100 PH	00264	13 x 17	4,10	190	96	10
100 PH	00274	14 x 17	4,10	190	97	10
100 PH	00284	16 x 17	4,35	205	124	10
100 PH	00534	16 x 18	4,90	220	110	10
100 PH	00294	17 x 19	5,35	220	156	10
100 PH	00304	18 x 19	5,35	220	156	10
100 PH	00074	18 x 21	8,60	235	214	10
100 PH	00324	19 x 22	6,35	235	209	10
100 PH	00334	20 x 22	6,35	237	200	10
100 PH	00344	21 x 23	7,10	250	235	5
100 PH	00354	19 x 24	7,20	245	240	5
100 PH	00514	21 x 24	9,20	250	230	5
100 PH	00364	22 x 24	7,30	250	244	5
100 PH	00384	24 x 26	8,25	270	320	5
100 PH	00394	24 x 27	7,95	270	295	5
100 PH	00404	24 x 30	10,30	285	360	5
100 PH	00414	25 x 28	10,05	280	370	5
100 PH	00434	27 x 30	11,70	295	466	5
100 PH	00444	27 x 32	11,70	302	468	5
100 PH	00454	30 x 32	11,70	295	492	5
100 PH	00614	30 x 34	21,10	320	477	3
100 PH	00464	30 x 36	18,35	320	526	3
100 PH	00644	32 x 34	24,95	323	600	3
100 PH	00474	32 x 36	19,50	323	600	3
100 PH	00624	34 x 36	24,95	323	586	3
100 PH	00484	36 x 41	24,50	350	723	3

Schraubenschlüssel Spanners & wrenches

280 PH



Ring-Maulschlüssel **ENERGY**
DIN 3113 Form A – ISO 3318
kurze Ausführung, Ringseite 15° abgewinkelt,
Chrom-Vanadium-Stahl, phosphatiert, Ringseite mit
ENERGY-Profil

Combination spanner **ENERGY**
DIN 3113 Form A – ISO 3318
short pattern, ring end 15° angled, chrome vanadium
steel, phosphatized **ENERGY**-profile at ring end

Artikel-Nr. Order-No.	Ident-Nr. Ident-No.	mm	€	L		
280 PH	05014	6	3,15	100	14	10
280 PH	05024	7	3,24	110	16	10
280 PH	05034	8	3,45	120	26	10
280 PH	05044	9	3,75	130	32	10
280 PH	05054	10	3,25	140	39	10
280 PH	05064	11	3,70	150	49	10
280 PH	05074	12	3,90	160	58	10
280 PH	05084	13	4,35	170	89	10
280 PH	05094	14	5,00	180	84	10
280 PH	05104	15	5,30	190	97	10
280 PH	05114	16	5,70	200	105	10
280 PH	05124	17	6,25	210	130	10
280 PH	05134	18	6,25	210	125	10
280 PH	05144	19	7,35	230	180	10
280 PH	05154	20	7,35	230	188	10
280 PH	05164	21	8,40	240	203	10
280 PH	05174	22	8,95	260	249	10
280 PH	05184	23	10,80	260	215	5
280 PH	05194	24	12,45	280	280	5
280 PH	05204	25	12,55	280	260	5
280 PH	05214	26	14,50	300	302	5
280 PH	05224	27	15,10	300	380	5
280 PH	05234	28	15,80	300	357	5
280 PH	05244	30	18,50	332	472	5
280 PH	05254	32	21,45	360	555	5
280 PH	04994	34	26,10	380	690	3
280 PH	05264	36	26,10	380	670	3

280 PH



Ring-Maulschlüssel **ENERGY**
DIN 3113 Form B – ISO 3318
ange Ausführung, Ringseite 15° gekröpft,
Chrom-Vanadium-Stahl, phosphatiert, **ENERGY**-Profil
auf der Ringseite

Combination spanner **ENERGY**
DIN 3113 Form B – ISO 3318
long pattern, ring end 15° offset, chrome vanadium
steel, phosphatized **ENERGY**-profile at ring end

Artikel-Nr. Order-No.	Ident-Nr. Ident-No.	mm	€	L		
290 PH	05954	6	3,80	110	21	10
290 PH	05964	7	3,90	120	23	10
290 PH	05724	8	3,95	130	30	10
290 PH	05734	9	4,25	140	36	10
290 PH	05744	10	3,90	150	45	10
290 PH	05754	11	4,05	160	54	10
290 PH	05764	12	4,54	170	62	10
290 PH	05774	13	4,95	175	74	10
290 PH	05784	14	5,30	185	90	10
290 PH	05794	15	5,90	195	101	10
290 PH	05804	16	6,25	210	122	10
290 PH	05814	17	7,10	230	144	10
290 PH	05824	18	7,40	240	155	10
290 PH	05834	19	8,05	250	186	10
290 PH	05844	20	8,60	250	214	10
290 PH	05854	21	10,50	285	276	10
290 PH	05864	22	10,80	285	293	10
290 PH	05874	23	11,25	330	273	5
290 PH	05884	24	13,90	330	392	5
290 PH	05894	25	16,35	355	453	5
290 PH	05904	26	17,15	355	442	5
290 PH	05914	27	19,55	360	486	5
290 PH	05924	28	19,90	361	458	5
290 PH	05934	30	22,55	395	637	5
290 PH	05944	32	25,30	435	755	5
290 PH	05704	34	39,65	435	983	3
290 PH	05974	36	39,65	470	952	3
290 PH	05984	41	51,00	475	1339	1

Doppel-Ringschlüssel **ENERGY**
 DIN 838 – ISO 3318
 gekröpft, Chrom-Vanadium-Stahl, phosphatiert,
ENERGY-Profil

Double ended ring spanner **ENERGY**
 DIN 838 – ISO 3318
 offset, chrome vanadium steel, phosphatized,
ENERGY profile

380 PH



Artikel-Nr. Order-No.	Ident-Nr. Ident-No.	mm	€	L		
380 PH	07304	6 x 7	4,05	175	53	10
380 PH	07284	7 x 8	6,50	179	55	10
380 PH	07314	8 x 9	4,30	179	70	10
380 PH	07324	8 x 10	4,10	185	69	10
380 PH	07334	9 x 11	4,70	193	84	10
380 PH	07344	10 x 11	4,30	197	84	10
380 PH	07364	10 x 13	4,95	220	111	10
380 PH	07384	11 x 13	5,40	218	117	10
380 PH	07404	12 x 13	5,95	222	113	10
380 PH	07414	12 x 14	5,40	225	125	10
380 PH	07424	13 x 14	6,20	224	152	10
380 PH	07434	13 x 15	6,20	225	161	10
380 PH	07444	14 x 15	5,95	230	157	10
380 PH	07744	13 x 16	6,75	248	183	10
380 PH	07454	13 x 17	6,90	245	186	10
380 PH	07464	14 x 17	7,00	248	182	10
380 PH	07474	16 x 17	7,30	251	199	10
380 PH	07484	16 x 18	7,40	251	211	10
380 PH	07494	17 x 19	8,90	290	257	10
380 PH	07504	18 x 19	8,65	285	266	10
380 PH	07294	18 x 21	12,45	285	322	10
380 PH	07514	19 x 22	10,35	297	295	10
380 PH	07524	20 x 22	10,35	300	324	10
380 PH	07534	19 x 24	10,55	311	350	5
380 PH	07544	21 x 23	10,75	315	356	5
380 PH	07824	21 x 24	11,75	312	384	5
380 PH	07554	22 x 24	11,75	312	379	5
380 PH	07564	24 x 26	13,60	335	437	5
380 PH	07574	24 x 27	13,50	324	474	5
380 PH	07584	24 x 30	15,55	343	587	5
380 PH	07594	25 x 28	16,85	340	577	5
380 PH	07604	27 x 30	16,85	343	600	5
380 PH	07614	27 x 32	18,05	383	630	5
380 PH	07624	30 x 32	19,70	383	623	5
380 PH	07764	30 x 34	22,80	400	643	3
380 PH	07634	30 x 36	24,95	400	810	3
380 PH	07834	32 x 34	28,30	395	790	3
380 PH	07644	32 x 36	25,20	395	790	3
380 PH	07844	34 x 36	28,75	395	862	3
380 PH	07654	36 x 41	35,75	445	1200	3



Doppelringschlüssel
 double ended ring spanner

Schraubenschlüssel Spanners & wrenches

360 PH



Doppelringschlüssel **ENERGY**

DIN 837 B – ISO 3318

gerade, Chrom-Vanadium-Stahl, phosphatiert,
ENERGY-Profil

Double ended ring spanner **ENERGY**

DIN 837 B – ISO 3318

straight, chrome vanadium steel, phosphatiert,
ENERGY-profile

Artikel-Nr. Order-No.	Ident-Nr. Ident-No.	mm	€	L		
360 PH	06524	6 x 7	3,65	97	12	10
360 PH	06534	8 x 9	3,85	115	16	10
360 PH	06544	8 x 10	3,15	115	19	10
360 PH	06554	9 x 11	5,10	125	25	10
360 PH	06564	10 x 11	2,95	125	27	10
360 PH	06574	10 x 13	3,05	140	33	10
360 PH	06594	11 x 13	3,05	140	33	10
360 PH	06614	12 x 13	3,30	140	41	10
360 PH	06624	12 x 14	3,35	145	40	10
360 PH	06604	13 x 14	3,85	155	46	10
360 PH	06634	13 x 15	3,90	155	46	10
360 PH	06864	13 x 16	4,85	155	46	10
360 PH	06644	14 x 15	3,55	155	50	10
360 PH	06654	13 x 17	4,05	170	67	10
360 PH	06664	14 x 17	4,35	170	65	10
360 PH	06674	16 x 17	4,35	170	70	10
360 PH	06684	16 x 18	4,60	170	65	10
360 PH	06694	17 x 19	5,15	185	84	10
360 PH	06704	18 x 19	5,25	190	83	10
360 PH	06884	18 x 21	7,95	200	128	10
360 PH	06714	19 x 22	6,20	200	124	10
360 PH	06724	20 x 22	6,00	200	120	10
360 PH	06734	21 x 23	7,10	215	142	5
360 PH	06924	21 x 24	8,35	215	144	5
360 PH	06744	22 x 24	7,55	215	144	5
360 PH	06764	24 x 26	8,50	255	201	5
360 PH	06774	24 x 27	8,50	255	199	5
360 PH	06784	25 x 28	8,95	265	217	5
360 PH	06804	27 x 32	13,75	280	260	5
360 PH	06814	30 x 32	12,85	285	292	5
360 PH	06944	30 x 34	17,60	330	380	5
360 PH	06824	30 x 36	16,55	330	380	3
360 PH	06834	32 x 36	19,10	330	427	3
360 PH	07034	34 x 36	22,85	330	382	1



Messestand
exhibition stand

Einmaulschlüssel

DIN 894 – ISO 3318

Spezial-Stahl, Maulstellung 15°,

bis Größe 38 mm: phosphatiert (PH)

ab Größe 41 mm: stahlgrau (SG)

Single open ended spanner

DIN 894 – ISO 3318

special steel, position of open end 15°,

up to size 38 mm: phosphatized (PH)

from size 41 mm: steel grey (SG)

180 PH



Artikel-Nr. Order-No.	Ident-Nr. Ident-No.	mm	€	L		
180 PH	02954	6	1,85	77	10	10
180 PH	02964	7	1,90	78	10	10
180 PH	02974	8	1,90	95	20	10
180 PH	02984	9	2,20	100	20	10
180 PH	02994	10	2,05	105	25	10
180 PH	03004	11	2,20	125	34	10
180 PH	03014	12	2,30	125	36	10
180 PH	03024	13	2,30	135	44	10
180 PH	03034	14	2,30	140	52	10
180 PH	03044	15	2,50	140	49	10
180 PH	02914	16	2,95	140	50	10
180 PH	03054	17	2,50	160	57	10
180 PH	03064	18	3,05	160	65	10
180 PH	03074	19	2,95	170	86	10
180 PH	03344	21	4,45	195	116	10
180 PH	03084	22	3,80	195	118	10
180 PH	03094	24	4,75	205	145	5
180 PH	03104	27	5,75	235	225	5
180 PH	03114	30	7,10	260	285	5
180 PH	03124	32	7,40	265	330	5
180 PH	03354	34	11,15	275	326	3
180 PH	03134	36	10,30	300	428	3
180 PH	02924	38	11,50	300	424	3

Stahlgrau

steel grey

Artikel-Nr. Order-No.	Ident-Nr. Ident-No.	mm	€	L		
180 SG	03145	41	12,75	345	545	3
180 SG	03155	46	16,35	375	800	3
180 SG	03165	50	21,25	410	980	1
180 SG	03175	55	23,95	455	1260	1
180 SG	03185	60	29,90	490	1650	1
180 SG	03195	65	41,30	575	1895	1
180 SG	03205	70	46,75	570	2340	1
180 SG	03215	75	75,00	610	2610	1
180 SG	03225	80	92,00	645	3330	1
180 SG	03235	85	115,00	690	3490	1
180 SG	03245	90	130,00	850	3455	1
180 SG	03255	95	190,00	850	6050	1
180 SG	03265	100	198,00	1000	5740	1
180 SG	03275	105	265,00	1000	8430	1
180 SG	03285	110	280,00	1000	8430	1
180 SG	03295	115	325,00	1000	7940	1
180 SG	03305	120	365,00	1000	8000	1
180 SG	03315	125	425,00	1000	8255	1
180 SG	03325	130	440,00	1000	7790	1
180 SG	03335	135	495,00	1000	7725	1

Schraubenschlüssel Spanners & wrenches

200 PH



Doppelmaulschlüssel
DIN 895 – ISO 3318/ISO 1085
Spezial-Stahl, Maulstellung 15°
bis Größe 34x36: phosphatiert (PH)
ab Größe 36x41: stahlgrau (SG)

Double open ended spanner
DIN 895 – ISO 3318/ISO 1085
special steel, position of open ends 15°,
up to size 34x36: phosphatized (PH)
from size 36x41: steel grey (SG)

Artikel-Nr. Order-No.	Ident-Nr. Ident-No.	mm	€	L		
200 PH	03404	6 x 7	1,85	95	12	10
200 PH	03414	7 x 8	2,40	108	20	10
200 PH	03424	7 x 9	2,65	110	20	10
200 PH	03434	8 x 9	2,05	117	28	10
200 PH	03444	8 x 10	2,05	115	28	10
200 PH	03474	9 x 10	3,95	123	31	10
200 PH	03484	9 x 11	2,40	122	28	10
200 PH	03494	10 x 11	2,35	122	31	10
200 PH	03804	10 x 12	4,20	125	35	10
200 PH	03504	10 x 13	2,35	123	45	10
200 PH	03514	10 x 14	4,20	140	54	10
200 PH	03524	11 x 13	3,05	140	54	10
200 PH	03534	11 x 14	2,70	140	54	10
200 PH	03544	12 x 13	2,50	142	50	10
200 PH	03554	12 x 14	2,50	142	55	10
200 PH	03564	13 x 14	3,50	160	53	10
200 PH	03574	13 x 15	2,70	160	69	10
200 PH	03364	13 x 16	3,15	160	74	10
200 PH	03584	13 x 17	2,85	160	74	10
200 PH	03814	14 x 15	3,75	160	74	10
200 PH	03594	14 x 17	2,85	160	66	10
200 PH	03824	16 x 17	3,75	170	70	10
200 PH	03374	16 x 18	3,35	170	104	10
200 PH	03604	17 x 19	3,40	193	99	10
200 PH	03614	17 x 22	4,45	170	143	10
200 PH	03934	18 x 19	3,75	195	99	10
200 PH	03384	18 x 21	4,95	195	123	10
200 PH	03624	19 x 22	4,10	205	140	10
200 PH	03634	19 x 24	5,05	195	191	10
200 PH	03944	20 x 22	4,95	206	119	10
200 PH	03954	21 x 23	5,45	205	208	5
200 PH	03834	21 x 24	5,65	220	208	5
200 PH	03644	22 x 24	5,30	235	216	5
200 PH	03654	22 x 27	6,20	244	250	5
200 PH	03664	24 x 27	6,40	265	257	5
200 PH	03674	24 x 30	7,45	244	283	5
200 PH	03964	25 x 28	7,55	270	257	5
200 PH	03794	27 x 30	9,25	270	360	5
200 PH	03684	27 x 32	9,25	273	408	5
200 PH	03694	30 x 32	9,25	305	450	5
200 PH	03844	30 x 34	11,50	305	453	5
200 PH	03704	30 x 36	11,70	305	528	1
200 PH	03714	32 x 36	11,95	305	534	1
200 PH	03924	34 x 36	14,10	305	537	1

Stahlgrau

steel grey

Artikel-Nr. Order-No.	Ident-Nr. Ident-No.	mm	€	L		
200 SG	03725	36 X 41	16,10	340	705	1
200 SG	03735	41 X 46	20,65	380	985	1
200 SG	03745	46 X 50	28,20	420	1170	1
200 SG	03755	50 X 55	35,32	460	1530	1
200 SG	03765	55 X 60	50,00	500	1645	1
200 SG	03775	65 X 70	89,05	580	2865	1
200 SG	03785	75 X 80	138,70	660	3960	1

Hakenschlüssel mit Nase
DIN 1810 Form A
für Nutmütern nach DIN 1804,
Spezial-Stahl, angelassen, schwarz

Hook wrenches with nose
DIN 1810 Form A
for slotted nuts as per DIN 1804,
special steel, tempered, black

260 S



Artikel-Nr. Order-No.	Ident-Nr. Ident-No.	mm	€	L		
260 S	04534	12/ 14	6,05	110	25	10
260 S	04544	16/ 20	6,05	110	25	10
260 S	04554	25/ 28	6,30	136	45	10
260 S	04564	30/ 32	7,25	136	50	10
260 S	04574	34/ 36	7,25	170	90	10
260 S	04584	40/ 42	7,25	170	90	10
260 S	04594	45/ 50	8,55	206	155	10
260 S	04604	52/ 55	8,55	206	160	10
260 S	04614	58/ 62	12,80	242	255	10
260 S	04624	68/ 75	12,80	242	255	10
260 S	04634	80/ 90	17,50	280	410	10
260 S	04644	95/100	17,50	280	385	10
260 S	04654	110/115	30,40	335	745	I
260 S	04664	120/130	30,40	335	720	I
260 S	04674	135/145	36,95	385	1000	I
260 S	04684	155/165	36,95	385	965	I
260 S	04694	180/195	61,90	470	1580	I
260 S	04704	205/220	61,90	470	1580	I
260 S	04714	230/245	106,15	560	2250	I
260 S	04724	260/270	106,15	568	2250	I
260 S	04734	280/300	235,70	680	5000	I
260 S	04744	380/400	314,95	770	6700	I

Hakenschlüssel mit Zapfen
DIN 1810 Form B
für Kreuzlochmütern gemäß DIN 1816,
Spezial-Stahl, angelassen, schwarz

Hook wrench with pin
DIN 1810 Form B
for round nuts with pin holes as per DIN 1816,
special steel, tempered, black

265 S



Artikel-Nr. Order-No.	Ident-Nr. Ident-No.	mm	€	L		
265 S	04526	12/ 14	6,45	110	25	10
265 S	04536	16/ 18	6,45	110	40	10
265 S	04546	20/ 22	6,45	110	40	10
265 S	04556	25/ 28	7,45	136	55	10
265 S	04566	30/ 32	7,45	136	55	10
265 S	04576	34/ 36	8,60	170	100	10
265 S	04586	40/ 42	8,60	170	100	10
265 S	04596	45/ 50	10,75	205	165	10
265 S	04606	52/ 55	10,75	205	165	10
265 S	04616	58/ 62	15,10	240	270	10
265 S	04626	68/ 75	15,10	240	270	10
265 S	04636	80/ 90	17,50	280	410	10
265 S	04646	95/100	17,50	280	410	10
265 S	04656	110/115	30,75	335	780	I
265 S	04666	120/130	30,75	335	780	I
265 S	04676	135/145	40,20	380	1000	I
265 S	04686	155/165	40,20	380	1000	I
265 S	04696	180/195	67,35	470	1580	I
265 S	04706	205/220	67,35	470	1580	I
265 S	04716	230/245	121,75	560	2250	I
265 S	04726	260/270	121,75	570	2250	I

Schraubenschlüssel Spanners & wrenches

440

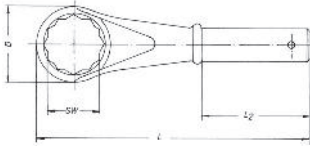
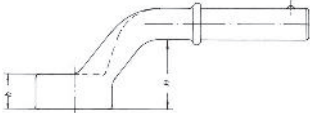

Aufsteck-Ringschlüssel
gekröpft, für schwere Zug-Beanspruchung, Chrom-
Vanadium-Stahl, verchromt, zur Verwendung mit
Aufsteckrohren No. 440 I bis IV (bitte extra bestellen)

Heavy duty single ended offset ring spanner
chrome vanadium steel, chrome plated,
to be used with tubes No. 440 I to IV
(please, order separately)

Artikel-Nr. Order-No.	Ident-Nr. Ident-No.	mm	€	Rohr Ø Tube Ø	D	h	H	L	L2		
440	0855 I	24	30,20	I	38	17	30	180	85	365	1
440	0856 I	27	31,40	I	41	17	32	190	90	400	1
440	0857 I	30	34,00	I	48	18	34	200	95	490	1
440	0858 I	32	36,10	II	49	18	34	235	116	730	1
440	0859 I	36	41,90	II	55	20	36	245	120	770	1
440	0860 I	41	50,20	II	62	22	40	265	129	950	1
440	0861 I	46	57,90	III	69	23	40	280	129	1300	1
440	0862 I	50	65,90	III	76	26	43	290	129	1450	1
440	0863 I	55	72,60	III	81	28	46	300	136	1750	1
440	0864 I	60	92,40	IV	90	31	49	345	156	2300	1
440	0865 I	65	102,50	IV	98	33	53	355	158	2600	1
440	0866 I	70	116,15	IV	105	36	55	365	160	2850	1
440	0867 I	75	130,80	IV	110	38	58	375	161	2900	1
440	0868 I	80	155,00	IV	125	41	59	385	170	3900	1
440	0869 I	85	157,00	IV	125	41	59	385	170	4000	1
440	0870 I	90	285,00	IV	140	45	63	410	170	4800	1
440	0871 I	95	310,00	IV	140	45	63	410	170	4800	1
440	0872 I	100	340,00	IV	143	45	63	412	170	4900	1
440	0873 I	105	360,00	IV	146	45	63	415	170	4900	1

440 R



Aufsteckrohr
für Ringschlüssel, Stahlrohr, verchromt

Tube
for above spanners, steel tube, chrome plated

Artikel-Nr. Order-No.	Ident-Nr. Ident-No.	Nr. No.	€	Rohr Ø Tube Ø	L	
440 R	0875 I	I	24,70	25	460	600
440 R	0876 I	II	28,50	27	610	1100
440 R	0877 I	III	51,30	32	760	2100
440 R	0878 I	IV	64,40	38	860	2900

460 SG



Ringschlüssel
DIN 3111
gerade, Spezial-Stahl, stahlgrau (SG)

Ring spanner
DIN 3111
straight, special steel, steel grey (SG)

Artikel-Nr. Order-No.	Ident-Nr. Ident-No.	mm	€	L		
460 SG	09005	13	21,65	140	70	1
460 SG	09015	14	19,00	140	70	1
460 SG	09025	17	19,30	155	100	1
460 SG	09035	19	20,45	170	110	1
460 SG	09045	22	24,00	190	150	1
460 SG	09055	24	24,00	215	200	1
460 SG	09065	27	27,00	230	250	1
460 SG	09075	30	30,00	255	320	1
460 SG	09085	32	31,50	265	360	1
460 SG	09095	36	38,00	295	520	1
460 SG	09105	41	42,40	330	780	1
460 SG	09115	46	53,25	365	920	1
460 SG	09125	50	64,15	400	1250	1
460 SG	09135	55	76,00	445	1500	1
460 SG	09145	60	93,00	475	1900	1
460 SG	09155	65	115,00	510	2400	1
460 SG	09165	70	132,00	555	2700	1
460 SG	09175	75	155,00	590	3500	1
460 SG	09185	80	178,20	620	4100	1
460 SG	09195	85	200,00	665	4700	1
460 SG	09205	90	255,00	700	5300	1
460 SG	09215	95	288,00	700	5800	1

Schlag-Ringschlüssel



Freimaßtoleranz nach DIN 7168B

für schwerste Beanspruchung, geeignet für tieferliegenden Schrauben, Chrom-Vanadium-Stahl, phosphatiert

Slugging ring spanner



tolerance as per DIN 7168B

for highest requirements, suited for deeper seated bolts, chrome vanadium steel, phosphatized

480 PH

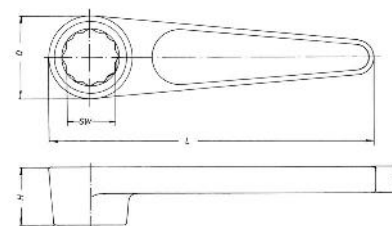

Artikel-Nr. Order-No.	Ident-Nr. Ident-No.	mm	€	D	H	b	L	Weight	Icon
480 PH	09247	19	107,55	37	21	10	390	700	I
480 PH	09257	22	107,55	37	21	10	390	700	I
480 PH	09267	24	113,00	45	25	10	400	750	I
480 PH	09277	27	113,00	45	25	10	400	750	I
480 PH	09287	30	140,10	50	30	12	410	1100	I
480 PH	09297	32	140,10	50	30	12	410	1100	I
480 PH	09307	36	216,20	59	34	13	425	1400	I
480 PH	09317	41	225,95	67	41	16	475	2500	I
480 PH	09327	46	237,90	76	47	17	510	2900	I
480 PH	09337	50	289,95	81	49	20	550	3700	I
480 PH	09347	55	342,20	87	52	16	560	4000	I
480 PH	09357	60	400,70	96	56	17	660	5200	I
480 PH	09367	65	513,80	100	62	19	690	6400	I
480 PH	09377	70	1162,00	104	70	20	700	7500	I
480 PH	09387	75	1172,00	110	72	20	700	8300	I
480 PH	09397	80	1485,00	115	75	22	700	9700	I
480 PH	09407	85	1627,60	125	75	22	750	11000	I
480 PH	09417	90	1770,50	136	80	23	750	13600	I
480 PH	09427	95	1846,00	143	82	23	800	15000	I
480 PH	09437	100	2145,00	150	90	24	850	16800	I
480 PH	09447	105	2443,00	157	95	25	900	18800	I
480 PH	09457	110	2693,00	165	100	25	950	20500	I
480 PH	09467	115	2878,00	173	100	26	1000	23500	I
480 PH	09477	120	2988,00	180	110	26	1000	25600	I



Messestand
exhibition stand

Schraubenschlüssel Spanners & wrenches

520 SG

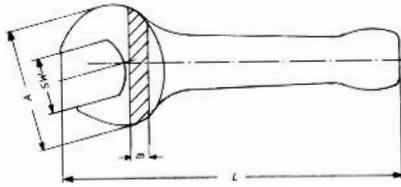

Schlag-Maulschlüssel
DIN 133
Spezial-Stahl, stahlgrau (SG)
Zwischengrößen auf Anfrage

Open jaw slugging wrench
DIN 133
special steel, steel grey (SG)
special sizes on request

Artikel-Nr. Order-No.	Ident-Nr. Ident-No.	mm	€	Ident-Nr. Ident-No.	AF ^z	€	A	m	L	⚖	📄
520 SG	09505	24	17,20				56	16	180	400	1
520 SG	09515	27	17,20	09516	1 1/16	21,50	56	16	180	400	1
520 SG	09525	30	20,20	09517	1 1/8	21,50	62	17	190	500	1
520 SG	09535	32	21,40	09526	1 3/16	24,80	62	17	190	500	1
520 SG				09536	1 1/4	26,10	62	17	190	500	1
520 SG	09545	36	27,20	09537	1 5/16	26,10	76	18	215	550	1
520 SG				09546	1 3/8	32,80	76	18	215	550	1
520 SG				09547	1 7/16	32,80	76	18	215	550	1
520 SG	09555	41	33,70	09548	1 1/2	32,80	86	19	235	900	1
520 SG				09556	1 9/16	40,90	86	19	235	900	1
520 SG				09557	1 5/8	39,50	86	19	235	900	1
520 SG	09565	46	45,50	09558	1 11/16	40,90	98	20	255	1200	1
520 SG				09566	1 3/4	54,80	98	20	255	1200	1
520 SG				09567	1 13/16	54,80	98	20	255	1200	1
520 SG	09575	50	52,20	09568	1 7/8	54,80	105	21	275	1500	1
520 SG				09576	1 15/16	63,00	105	21	275	1500	1
520 SG				09577	2	63,00	105	21	275	1500	1
520 SG	09585	55	60,80	09578	2 1/16	63,00	116	23	300	1900	1
520 SG				09586	2 1/8	72,90	116	23	300	1900	1
520 SG				09587	2 3/16	72,90	116	23	300	1900	1
520 SG	09595	60	68,00	09588	2 1/4	72,90	128	25	320	2600	1
520 SG				09596	2 5/16	82,50	128	25	320	2600	1
520 SG				09597	2 3/8	82,50	128	25	320	2600	1
520 SG	09605	65	87,00	09598	2 7/16	82,50	138	27	340	3400	1
520 SG				09606	2 1/2	105,00	138	27	340	3400	1
520 SG				09607	2 9/16	105,00	138	27	340	3400	1
520 SG	09615	70	112,00	09608	2 5/8	105,00	154	30	375	4400	1
520 SG	09625	75	122,00	09616	2 3/4	136,50	154	30	375	4400	1
520 SG				09617	2 13/16	136,50	154	30	375	4400	1
520 SG				09618	2 7/8	136,50	154	30	375	4300	1
520 SG				09626	2 15/16	143,00	154	30	375	4300	1
520 SG	09635	80	155,00	09627	3	143,00	174	34	410	6300	1
520 SG	09645	85	162,00	09636	3 1/8	185,00	174	34	410	6300	1
520 SG				09637	3 1/4	185,00	174	34	410	6200	1
520 SG	09655	90	200,00	09646	3 3/8	195,00	194	38	445	7300	1
520 SG	09665	95	220,00	09656	3 1/2	240,00	194	38	445	7300	1
520 SG				09657	3 5/8	240,00	194	38	445	7100	1
520 SG	09675	100	325,00	09666	3 3/4	255,00	215	44	485	12200	1
520 SG	09685	105	375,00	09676	3 7/8	395,00	215	44	485	12200	1
520 SG				09677	4	395,00	215	44	485	11900	1
520 SG	09695	110	422,00	09686	4 1/8	450,00	235	47	510	13500	1
520 SG	09705	115	485,00	09696	4 1/4	495,00	235	47	510	13200	1
520 SG	09715	120	495,00	09706	4 1/2	575,00	255	50	545	15500	1
520 SG	09725	125	542,00	09716	4 3/4	595,00	255	50	545	15200	1
520 SG	09735	130	725,00	09726	5	750,00	275	55	575	19300	1
520 SG	09745	135	735,00				275	55	575	19000	1
520 SG	09755	140	795,00				275	55	575	19000	1
520 SG	09765	145	1150,00				305	60	640	29000	1
520 SG	09775	150	1150,00				305	60	640	28600	1
520 SG	09785	155	1225,00				305	60	640	28200	1
520 SG	09795	160	1350,00				305	60	640	28000	1
520 SG	09805	165	1470,00				342	70	715	37000	1
520 SG	09815	170	2100,00				342	70	715	36600	1
520 SG	09825	175	2150,00				342	70	715	36200	1
520 SG	09835	180	2350,00				342	70	715	35800	1
520 SG	09845	185	2400,00				342	70	715	35400	1
520 SG	09855	190	2600,00				392	78	800	39500	1
520 SG	09865	195	2720,00				392	78	800	39000	1
520 SG	09875	200	2950,00				392	78	800	38500	1
520 SG	09885	205	3200,00				392	78	800	38300	1
520 SG	09895	210	3520,00				392	78	800	38000	1
520 SG	09905	215	4100,00				392	78	800	38000	1
520 SG	09915	220	4600,00				415	80	800	37800	1

Schlag-Maulschlüssel

Maulstellungen: 15°

für schwerste Beanspruchung, Freiformschmiedestücke, Chrom-Vanadium-Stahl, phosphatiert

Open end slugging wrench

positions of open end: 15°

for highest requirements, hammer forged, chrome vanadium steel, phosphatized

540 PH

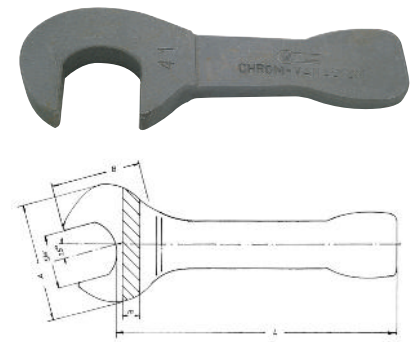

Artikel-Nr. Order-No.	Ident-Nr. Ident-No.	mm	€	A	B	m	L		
540 PH	09987	41	389,00	92	70	20	180	1600	I
540 PH	09997	46	407,00	96	74	20	200	1800	I
540 PH	10007	50	413,00	108	78	20	225	2200	I
540 PH	10017	55	462,00	115	86	25	250	3200	I
540 PH	10027	60	538,00	125	93	25	250	3200	I
540 PH	10037	65	663,00	142	101	30	280	3500	I
540 PH	10047	70	717,00	154	106	30	280	6500	I
540 PH	10057	75	826,00	160	112	35	320	6900	I
540 PH	10067	80	1032,00	166	115	35	320	6900	I
540 PH	10077	85	1184,00	175	128	35	320	7200	I
540 PH	10087	90	1293,00	200	142	40	320	7900	I
540 PH	10097	95	1325,00	200	142	40	360	9400	I
540 PH	10107	100	1511,00	230	148	48	400	14000	I
540 PH	10117	105	1597,00	240	148	48	400	14000	I
540 PH	10127	110	1618,00	240	160	48	400	15000	I
540 PH	10137	115	1738,00	250	175	56	425	17000	I
540 PH	10147	120	1834,00	250	175	56	425	18000	I

Maulstellungen: 45°

positions of open end: 45°

Artikel-Nr. Order-No.	Ident-Nr. Ident-No.	mm	€	A	B	m	L		
540 PH	10187	41	389,00	92	70	20	180	1600	I
540 PH	10197	46	407,00	96	74	20	200	1800	I
540 PH	10207	50	413,00	108	78	20	225	2200	I
540 PH	10217	55	462,00	115	86	25	250	3200	I
540 PH	10227	60	538,00	125	93	25	250	3200	I
540 PH	10237	65	663,00	142	101	30	280	3500	I
540 PH	10247	70	717,00	154	106	30	280	6500	I
540 PH	10257	75	826,00	160	112	35	320	6900	I
540 PH	10267	80	1032,00	166	115	35	320	6900	I
540 PH	10277	85	1184,00	175	128	35	320	7200	I
540 PH	10287	90	1293,00	200	142	40	320	7900	I
540 PH	10297	95	1325,00	200	142	40	360	9400	I
540 PH	10307	100	1511,00	230	148	48	400	14000	I
540 PH	10317	105	1597,00	240	148	48	400	14000	I
540 PH	10327	110	1618,00	240	160	48	400	15000	I
540 PH	10337	115	1738,00	250	175	56	425	17000	I
540 PH	10347	120	1834,00	250	175	56	425	18000	I

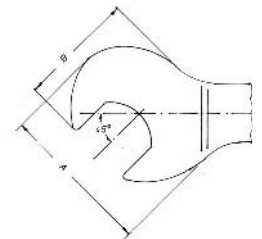

Maulstellungen: 90°

positions of open end: 90°

Artikel-Nr. Order-No.	Ident-Nr. Ident-No.	mm	€	A	B	m	L		
540 PH	10387	41	389,00	92	70	20	180	1600	I
540 PH	10397	46	407,00	96	74	20	200	1800	I
540 PH	10407	50	413,00	108	78	20	225	2200	I
540 PH	10417	55	462,00	115	86	25	250	3200	I
540 PH	10427	60	538,00	125	93	25	250	3200	I
540 PH	10437	65	663,00	142	101	30	280	3500	I
540 PH	10447	70	717,00	154	106	30	280	6500	I
540 PH	10457	75	826,00	160	112	35	320	6900	I
540 PH	10467	80	1032,00	166	115	35	320	6900	I
540 PH	10477	85	1184,00	175	128	35	320	7200	I
540 PH	10487	90	1293,00	200	142	40	320	7900	I
540 PH	10497	95	1325,00	200	142	40	360	9400	I
540 PH	10507	100	1511,00	230	148	48	400	14000	I
540 PH	10517	105	1597,00	240	148	48	400	14000	I
540 PH	10527	110	1618,00	240	160	48	400	15000	I
540 PH	10537	115	1738,00	250	175	56	425	17000	I
540 PH	10547	120	1834,00	250	175	56	425	18000	I

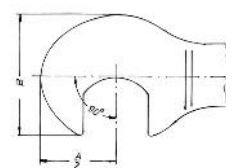

Schraubenschlüssel Spanners & wrenches

560 PH

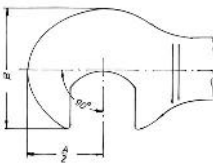
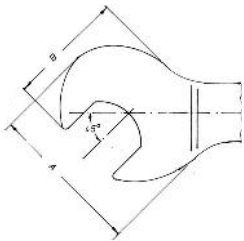
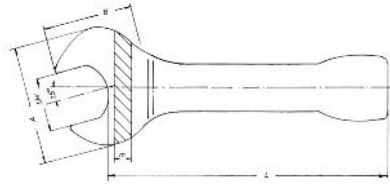

Einmaulschlüssel

Maulstellungen: 15°

für schwerste Zugbeanspruchung, besonders lang,
legierter Sonderstahl, phosphatiert

Single ended open jaw spanner

positions of open end: 15°

for highest tightening requirements, extra long, special
alloy steel, phosphatized

Artikel-Nr. Order-No.	Ident-Nr. Ident-No.	mm	€	A	B	m	L		
560 PH	10597	22	191,00	55	45	10	400	600	I
560 PH	10607	24	196,00	62	45	10	400	600	I
560 PH	10617	27	196,00	66	50	10	425	800	I
560 PH	10627	30	229,00	75	60	12	500	1200	I
560 PH	10637	32	229,00	75	60	12	500	1200	I
560 PH	10647	36	294,00	75	65	15	550	1500	I
560 PH	10657	41	338,00	90	75	16	600	2000	I
560 PH	10667	46	414,00	100	75	20	650	2300	I
560 PH	10677	50	435,00	110	85	20	700	3100	I
560 PH	10687	55	474,00	120	90	20	750	3700	I
560 PH	10697	60	630,00	132	100	20	800	4300	I
560 PH	10707	65	706,00	135	100	20	800	4500	I
560 PH	10717	70	783,00	172	105	20	850	5600	I
560 PH	10727	75	869,00	172	110	25	900	6700	I
560 PH	10737	80	1035,00	172	120	25	1000	7600	I

Maulstellungen: 45°

positions of open end: 45°

Artikel-Nr. Order-No.	Ident-Nr. Ident-No.	mm	€	A	B	m	L		
560 PH	10867	22	191,00	55	45	10	400	600	I
560 PH	10877	24	196,00	62	45	10	400	600	I
560 PH	10887	27	196,00	66	50	10	425	800	I
560 PH	10897	30	229,00	75	60	12	500	1200	I
560 PH	10907	32	229,00	75	60	12	500	1200	I
560 PH	10917	36	294,00	75	65	15	550	1500	I
560 PH	10927	41	338,00	90	75	16	600	2000	I
560 PH	10937	46	414,00	100	75	20	650	2300	I
560 PH	10947	50	435,00	110	85	20	700	3100	I
560 PH	10957	55	474,00	120	90	20	750	3700	I
560 PH	10967	60	630,00	132	100	20	800	4300	I
560 PH	10977	65	706,00	135	100	20	800	4500	I
560 PH	10987	70	783,00	172	105	20	850	5600	I
560 PH	10997	75	869,00	172	110	25	900	6700	I
560 PH	11007	80	1035,00	172	120	25	1000	7600	I

Maulstellungen: 90°



positions of open end: 90°

Artikel-Nr. Order-No.	Ident-Nr. Ident-No.	mm	€	A	B	m	L		
560 PH	11167	22	191,00	55	45	10	400	600	I
560 PH	11177	24	196,00	62	45	10	400	600	I
560 PH	11187	27	196,00	66	50	10	425	800	I
560 PH	11197	30	229,00	75	60	12	500	1200	I
560 PH	11207	32	229,00	75	60	12	500	1200	I
560 PH	11217	36	294,00	75	65	15	550	1500	I
560 PH	11227	41	338,00	90	75	16	600	2000	I
560 PH	11237	46	414,00	100	75	20	650	2300	I
560 PH	11247	50	435,00	110	85	20	700	3100	I
560 PH	11257	55	474,00	120	90	20	750	3700	I
560 PH	11267	60	630,00	132	100	20	800	4300	I
560 PH	11277	65	706,00	135	100	20	800	4500	I
560 PH	11287	70	783,00	172	105	20	850	5600	I
560 PH	11297	75	869,00	172	110	25	900	6700	I
560 PH	11307	80	1035,00	172	120	25	1000	7600	I

Schlag-Ringschlüssel
DIN 7444
Spezial-Stahl, stahlgrau (SG)
Zwischengrößen auf Anfrage

Slugging ring wrench
DIN 7444
special steel, steel grey (SG)
special sizes on request

580 SG

Artikel-Nr. Order-No.	Ident-Nr. Ident-No.	mm	€	Ident-Nr. Ident-No.	AF"	€	D	m	L		
580 SG	11425	24	19,20				43	15	165	400	I
580 SG	11435	27	23,40	11436	1 ¹ / ₁₆	29,00	46	16	180	400	I
580 SG				11437	1 ¹ / ₈	29,00	46	16	180	400	I
580 SG	11445	30	29,00	11446	1 ³ / ₁₆	34,00	52	17	190	500	I
580 SG	11455	32	29,50	11456	1 ¹ / ₄	35,00	52	17	190	500	I
580 SG				11457	1 ⁵ / ₁₆	35,00	52	17	190	500	I
580 SG	11465	36	37,00	11466	1 ³ / ₈	45,00	58	18	205	500	I
580 SG				11467	1 ⁷ / ₁₆	45,00	58	18	205	500	I
580 SG				11468	1 ¹ / ₂	45,00	58	18	205	500	I
580 SG	11475	41	47,80	11476	1 ⁹ / ₁₆	59,00	66	20	230	800	I
580 SG				11477	1 ⁵ / ₈	59,00	66	20	230	800	I
580 SG				11478	1 ¹¹ / ₁₆	59,00	66	20	230	800	I
580 SG	11485	46	51,00	11486	1 ³ / ₄	62,00	74	22	240	1000	I
580 SG				11487	1 ¹³ / ₁₆	62,00	74	22	240	1000	I
580 SG				11488	1 ⁷ / ₈	62,00	74	22	240	1000	I
580 SG	11495	50	60,00	11496	1 ¹⁵ / ₁₆	72,00	80	24	255	1100	I
580 SG				11497	2	72,00	80	24	255	1100	I
580 SG				11498	2 ¹ / ₁₆	72,00	80	24	255	1100	I
580 SG	11505	55	66,80	11506	2 ¹ / ₈	82,00	86	25	270	1500	I
580 SG				11507	2 ³ / ₁₆	82,00	86	25	270	1500	I
580 SG				11508	2 ¹ / ₄	82,00	86	25	270	1500	I
580 SG	11515	60	71,00	11516	2 ⁵ / ₁₆	87,00	93	26	280	1800	I
580 SG				11517	2 ³ / ₈	87,00	93	26	280	1800	I
580 SG				11518	2 ⁷ / ₁₆	87,00	93	26	280	1800	I
580 SG	11525	65	94,00	11526	2 ¹ / ₂	112,00	102	30	300	2200	I
580 SG				11527	2 ⁹ / ₁₆	112,00	102	30	300	2200	I
580 SG				11528	2 ⁵ / ₈	112,00	102	30	300	2200	I
580 SG	11535	70	104,00	11536	2 ³ / ₄	130,00	110	33	330	3300	I
580 SG				11537	2 ¹³ / ₁₆	130,00	110	33	330	3300	I
580 SG	11545	75	110,00	11538	2 ⁷ / ₈	135,00	110	33	330	3300	I
580 SG				11546	2 ¹⁵ / ₁₆	135,00	110	33	330	3300	I
580 SG				11547	3	135,00	110	33	330	3300	I
580 SG	11555	80	163,00	11556	3 ¹ / ₈	205,00	126	36	360	4500	I
580 SG	11565	85	200,00	11557	3 ¹ / ₄	200,00	126	36	360	4500	I
580 SG				11566	3 ³ / ₈	240,00	126	36	360	4300	I
580 SG	11575	90	240,00	11576	3 ¹ / ₂	290,00	142	40	390	5500	I
580 SG	11585	95	270,50	11577	3 ⁵ / ₈	290,00	142	40	420	5300	I
580 SG				11586	3 ³ / ₄	330,00	155	45	420	6500	I
580 SG	11595	100	305,00	11596	3 ⁷ / ₈	370,00	155	45	420	6500	I
580 SG	11605	105	355,00	11597	4	370,00	155	45	420	6500	I
580 SG				11606	4 ¹ / ₈	420,00	155	45	420	6200	I
580 SG	11615	110	400,00	11616	4 ¹ / ₄	462,00	170	48	450	8000	I
580 SG	11625	115	430,00	11626	4 ¹ / ₂	510,00	170	48	450	7800	I
580 SG				11627	4 ⁵ / ₈	510,00	170	48	450	7800	I
580 SG	11635	120	690,00	11636	4 ³ / ₄	810,00	182	54	480	10000	I
580 SG	11645	125	890,00	11646	5	1100,00	182	54	480	9700	I
580 SG	11655	130	1000,00				202	58	520	13200	I
580 SG	11665	135	1050,00				202	58	520	13000	I
580 SG	11675	140	1150,00				210	58	520	18500	I
580 SG	11685	145	1550,00				228	64	580	18500	I
580 SG	11695	150	1600,00				228	64	580	18200	I
580 SG	11705	155	1720,00				228	64	580	18000	I
580 SG	11715	160	1800,00				240	64	580	17800	I
580 SG	11725	165	1880,00				265	70	650	26500	I
580 SG	11735	170	2280,00				265	70	650	26000	I
580 SG	11745	175	2500,00				265	70	650	25500	I
580 SG	11755	180	2850,00				265	70	650	25000	I
580 SG	11765	185	2850,00				290	75	700	33000	I
580 SG	11775	190	3050,00				290	75	700	32500	I
580 SG	11785	195	3100,00				290	75	700	32000	I
580 SG	11795	200	3150,00				290	75	700	31500	I
580 SG	11805	205	3200,00				320	80	750	32000	I
580 SG	11815	210	3320,00				320	80	750	32000	I
580 SG	11825	215	3750,00				320	80	750	32000	I
580 SG	11835	220	4200,00				320	80	750	32000	I
580 SG	11845	225	4700,00				320	80	750	31600	I
580 SG	11855	230	5100,00				320	80	750	31000	I

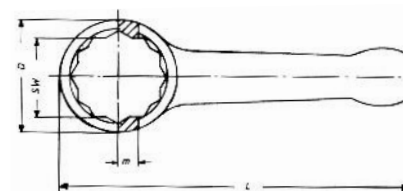

Schraubenschlüssel Spanners & wrenches

620 PH

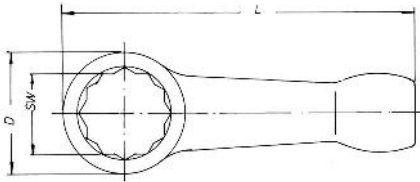

Schlag-Ringschlüssel

extra Qualität „stärker als die Schraube“, besonders dünnwandige, hohe Ringe, Chrom-Vanadium-Stahl, phosphatiert, für tieferliegende Schrauben, Kombinationsmöglichkeit mit unserem Schlagschlüssel-Einsatz No. 625 PH

Slugging ring wrench

extra quality „stronger than the bolt“, especially thin-walled, but high rings, chrome vanadium steel, phosphatized, for deeper seated bolts, combine with our impact socket Nr. 625 PH

Artikel-Nr. Order-No.	Ident-Nr. Ident-No.	mm	€	D	h	L		
620 PH	11927	30	70,65	42	24	190	500	I
620 PH	11937	32	70,63	47	24	195	500	I
620 PH	11947	36	80,35	52	26	195	600	I
620 PH	11957	41	92,35	59	29	200	800	I
620 PH	11967	46	97,75	65	32	250	1000	I
620 PH	11977	50	109,00	70	35	280	1300	I
620 PH	11987	55	125,00	76	38	300	1700	I
620 PH	11997	60	142,00	83	42	300	2000	I
620 PH	12007	65	169,00	90	45	325	2600	I
620 PH	12017	70	180,00	97	48	365	3800	I
620 PH	12027	75	213,00	104	51	365	4500	I
620 PH	12037	80	267,00	110	57	440	5800	I
620 PH	12047	85	273,00	117	57	440	6300	I
620 PH	12057	90	326,00	124	60	445	7200	I
620 PH	12067	95	359,00	131	67	450	8500	I
620 PH	12077	100	549,00	137	67	460	9800	I
620 PH	12087	105	489,00	146	73	460	11000	I
620 PH	12097	110	*	156	80	505	14500	I
620 PH	12107	115	*	162	80	505	15000	I
620 PH	12117	120	*	168	83	530	17000	I

* auf Anfrage

* on request

625 PH

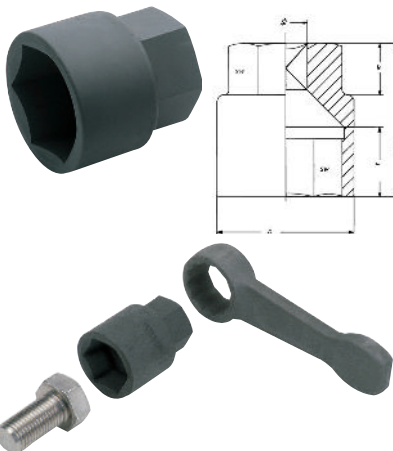

Schlagschlüssel-Einsatz

gleicher Innen- und Außensechskant, zur Verwendung mit Schlagschlüssel, No. 620 PH, für tieferliegende Schrauben, zusätzlicher Innen-Vierkant, Chrom-Vanadium-Stahl, phosphatiert

Heavy duty socket for slugging wrenches

male & female hexagon of same size, for use with slugging ring wrenches No. 620 PH for deeper seated bolts, female square drive adapter, chrome vanadium steel, phosphatized

Artikel-Nr. Order-No.	Ident-Nr. Ident-No.	mm	€	D	T	m	L		
625 PH	12157	41	212,00	59	28	35	80	740	I
625 PH	12167	46	218,00	65	30	35	82	900	I
625 PH	12177	50	250,00	70	32	35	85	1120	I
625 PH	12187	55	271,50	76	35	35	90	1420	I
625 PH	12197	60	282,50	83	37	35	95	1680	I
625 PH	12207	65	326,00	91	38	35	100	2200	I
625 PH	12217	70	348,00	97	41	35	108	2830	I
625 PH	12227	75	391,00	104	44	35	112	3220	I
625 PH	12237	80	445,50	110	46	35	120	3900	I
625 PH	12247	85	674,00	117	50	45	127	4670	I
625 PH	12257	90	787,50	124	54	45	130	5510	I
625 PH	12267	95	869,00	131	56	45	140	6740	I
625 PH	12277	100	956,00	137	60	45	145	7580	I
625 PH	12287	105	1022,00	153	60	45	155	8910	I
625 PH	12297	110	1130,00	156	60	45	165	11300	I
625 PH	12307	115	1250,00	174	65	45	165	12340	I
625 PH	12317	120	1358,00	174	65	45	170	14500	I

Schlagschlüssel für Innensechskant-Schrauben 
 Chrom-Vanadium-Stahl, phosphatiert, zwei Ausführungen

Slugging wrench for allen screws 
 chrome vanadium steel, phosphatized,

630 PH

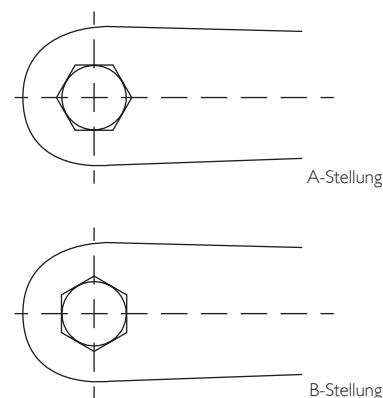



Artikel-Nr. Order-No.	Ident-Nr. Ident-No.	Form Style	mm	€	A	C	D	L	
630 PH	630 1700 040	A	17	275,00	30	62	52	195	I
630 PH	630 1701 040	B	17	275,00	30	62	52	195	I
630 PH	630 1900 040	A	19	282,00	30	62	52	195	I
630 PH	630 1901 040	B	19	282,00	30	62	52	195	I
630 PH	630 2200 040	A	22	289,00	30	62	52	195	I
630 PH	630 2201 040	B	22	289,00	30	62	52	195	I
630 PH	630 2400 040	A	24	294,00	30	62	52	195	I
630 PH	630 2401 040	B	24	294,00	30	62	52	195	I
630 PH	630 2700 040	A	27	299,00	30	68	52	195	I
630 PH	630 2701 040	B	27	299,00	30	68	52	195	I
630 PH	630 3000 040	A	30	350,00	30	74	58	195	I
630 PH	630 3001 040	B	30	350,00	30	74	58	195	I
630 PH	630 3200 040	A	32	415,00	30	74	58	195	I
630 PH	630 3201 040	B	32	415,00	30	74	58	195	I
630 PH	630 3600 040	A	36	455,00	30	80	58	195	I
630 PH	630 3601 040	B	36	455,00	30	80	58	195	I
630 PH	630 4100 040	A	41	460,00	30	83	72	250	I
630 PH	630 4101 040	B	41	460,00	30	83	72	250	I
630 PH	630 4600 040	A	46	465,00	30	89	72	250	I
630 PH	630 4601 040	B	46	465,00	30	89	72	250	I
630 PH	630 5000 040	A	50	698,00	30	93	88	300	I
630 PH	630 5001 040	B	50	698,00	30	93	88	300	I
630 PH	630 5500 040	A	55	810,00	30	95	88	300	I
630 PH	630 5501 040	B	55	810,00	30	95	88	300	I
630 PH	630 6000 040	A	60	880,00	30	99	88	300	I
630 PH	630 6001 040	B	60	880,00	30	99	88	300	I
630 PH	630 6500 040	A	65	945,00	30	100	104	300	I
630 PH	630 6501 040	B	65	945,00	30	100	104	300	I
630 PH	6307000 040	A	70	990,00	30	107	124	440	I
630 PH	630 7001 040	B	70	990,00	30	107	124	440	I
630 PH	630 7500 040	A	75	1090,00	30	107	124	440	I
630 PH	630 7501 040	B	75	1090,00	30	107	124	440	I
630 PH	630 8000 040	A	80	1150,00	30	112	124	440	I
630 PH	630 8001 040	B	80	1150,00	30	112	124	440	I
630 PH	630 9000 040	A	90	1280,00	30	130	164	500	I
630 PH	630 9001 040	B	90	1280,00	30	130	164	500	I
630 PH	630 9500 040	A	95	1300,00	30	130	164	500	I
630 PH	630 9501 040	B	95	1300,00	30	130	164	500	I

Schlagschlüssel COMPACT 
 Chrom-Vanadium-Stahl, phosphatiert, für schwere Beanspruchung, insbesondere bei beengten Platzverhältnissen

Slugging ring wrench COMPACT 
 chrome vanadium steel, phosphatized, for highest demands, especially for use on confined areas

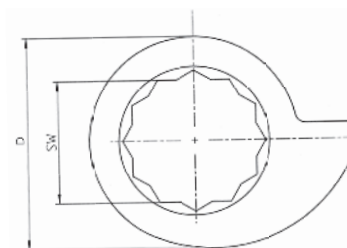
640 PH



Artikel-Nr. Order-No.	Ident-Nr. Ident-No.	mm	€	D	h		
640 PH	640 0270 040	27	103,00	52	25	270	I
640 PH	640 0300 040	30	113,50	54	27	290	I
640 PH	640 0320 040	32	113,50	56	27	300	I
640 PH	640 0360 040	36	127,50	62	30	380	I
640 PH	640 0410 040	41	138,50	68	33	460	I
640 PH	640 0460 040	46	146,00	78	35	460	I
640 PH	640 0500 040	50	161,00	82	38	820	I
640 PH	640 0550 040	55	175,00	90	40	980	I
640 PH	640 0600 040	60	188,00	98	40	1250	I

Schraubenschlüssel Spanners & wrenches

2364 PH

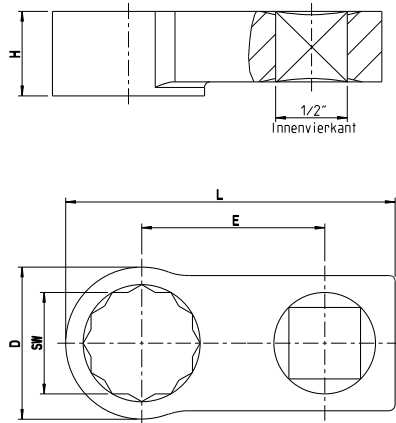

Ringverlängerung 1/2"
hochwertiger Chrom-Vanadium-Stahl, phosphatiert

Ring extension 1/2"
high quality chrome vanadium steel, phosphatized

Artikel-Nr. Order-No.	Ident-Nr. Ident-No.	€	SW	L	E	H
2364 PH	023640080700	*	8	70	50	6
2364 PH	023640090700	*	9	70	50	6
2364 PH	023640100720	*	10	72	50	6
2364 PH	023640110720	*	11	72	50	6
2364 PH	023640120740	*	12	74	50	8
2364 PH	023640130740	*	13	74	50	8
2364 PH	023640140740	*	14	74	50	8
2364 PH	023640150750	*	15	75	50	13
2364 PH	023640160770	*	16	77	50	13
2364 PH	023640170790	*	17	79	50	13
2364 PH	023640180800	*	18	80	50	13
2364 PH	023640190800	*	19	80	50	13
2364 PH	023640210815	*	21	81,5	50	13
2364 PH	023640220815	*	22	81,5	50	13
2364 PH	023640240840	*	24	84	50	15
2364 PH	023640270940	*	27	94	55	15
2364 PH	023640301000	*	30	100	60	20

* auf Anfrage

* on request

2365 PH

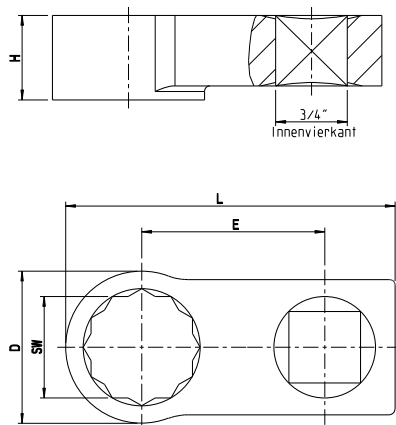

Ringverlängerung 3/4"
hochwertiger Chrom-Vanadium-Stahl, phosphatiert

Ring extension 3/4"
high quality chrome vanadium steel, phosphatized

Artikel-Nr. Order-No.	Ident-Nr. Ident-No.	€	SW	L	E	H
2365 PH	023650170820	*	17	82	55	20
2365 PH	023650190830	*	19	83	55	20
2365 PH	023650210880	*	21	88	55	25
2365 PH	023650220890	*	22	89	55	25
2365 PH	023650240920	*	24	92	55	25
2365 PH	023650270940	*	27	94	55	25
2365 PH	023650301010	*	30	101	60	25
2365 PH	023650321020	*	32	102	60	25
2365 PH	023650361030	*	36	103	60	30
2365 PH	023650411070	*	41	107	60	30
2365 PH	023650461200	*	46	120	70	30
2365 PH	023650501230	*	50	123	70	30
2365 PH	023650551400	*	55	140	85	30
2365 PH	023650601730	*	60	173	100	30

* auf Anfrage

* on request



Ringverlängerung
ring extension



offene Ringverlängerung
open ring extension



Sonder-Ringverlängerung
special ring extension

Ringverlängerung I“
hochwertiger Chrom-Vanadium-Stahl, phosphatiert

Ring extension I“
high quality chrome vanadium steel, phosphatized

2366 PH

Artikel-Nr. Order-No.	Ident-Nr. Ident-No.	€	SW	L	E	H
2366 PH	023660270940	*	27	94	55	25
2366 PH	023660301115	*	30	111,5	65	25
2366 PH	023660321130	*	32	113	65	25
2366 PH	023660361160	*	36	116	65	30
2366 PH	023660411250	*	41	125	70	30
2366 PH	023660461330	*	46	133	75	30
2366 PH	023660501360	*	50	136	75	35
2366 PH	023660551550	*	55	155	90	38
2366 PH	023360601630	*	60	163	95	41
2366 PH	023660651730	*	65	173	100	44
2366 PH	023660701830	*	70	183	105	47
2366 PH	023660752080	*	75	208	115	50
2366 PH	023660802150	*	80	215	120	57

* auf Anfrage

* on request

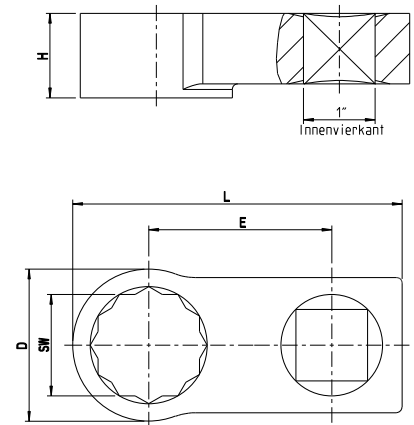

Offene Ringverlängerungen

Wir können alle Ringverlängerungen auch in einer offenen Ausführung liefern. Hierfür berechnen wir einen Fertigungsaufschlag von 30%.

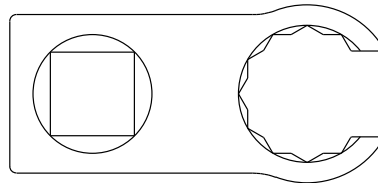
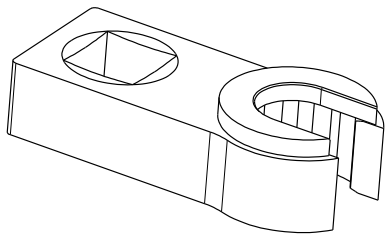

open ring extensions

Also we can deliver all ring extensions in an open design. For the open design we calculate a surcharge of 30%.

Sonder-Ringverlängerungen

Wir fertigen Verlängerungen nach Ihrer Konstruktion oder konstruieren nach Ihren Vorgaben.

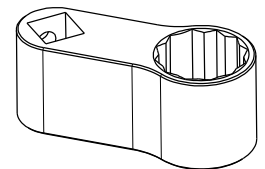
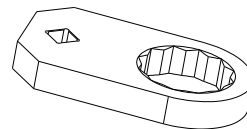
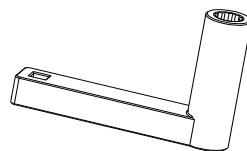
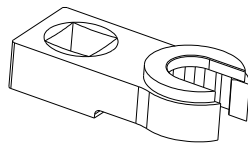
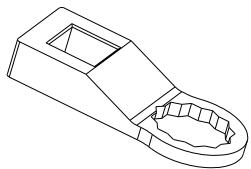

special ring extensions

We produce extensions according to your design or designs according to your demands